

ENCLOSURES

AND

ACCESSORIES



PERANO STEEL ENCLOSURES





SHORT FORM CATALOGUE





PERANO - WALL MOUNT METAL ENCLOSURES

MILD STEEL ENCLOSURES - IP65 - NO GLAND PLATE

PART NUMBER		DIMENSIONS (mm)			MATERIAL THICKNESS (mm)	WEIGHT (Kg)	CHASSIS THICKNESS (mm)	B26 / RAL7032
ORANGE	GREY	HEIGHT	WIDTH	DEPTH				
200-O	200-G	175	250	170	1.2	3	2.0	
201-O	201-G	350	250	170	1.2	6	2.0	
202-O	202-G	450	300	220	1.2	9	2.0	
203-O	203-G	550	400	220	1.2	13	2.0	
204-O	204-G	650	450	270	1.2	17	2.0 (*)	
205-O	205-G	750	550	270	1.6	27	2.0 (*)	
205A-O	205A-G	850	650	270	1.6	35	2.0 (*)	
206-O	206-G	950	700	270	1.6	41	2.0 (*)	
207-O	207-G	1 150	850	270	1.6	56	2.0 (*)	

(*) – FITTED WITH TWO LOCKS

MILD STEEL ENCLOSURES - IP66 - WITH REMOVABLE GLAND PLATE

PART NUMBER		DIMENSIONS (mm)			MATERIAL THICKNESS (mm)	WEIGHT (Kg)	CHASSIS THICKNESS (mm)	B26 / RAL7032
ORANGE	GREY	HEIGHT	WIDTH	DEPTH				
101-O	101-G	350	250	170	1.2	6	2.0	
102-O	102-G	450	300	220	1.2	9	2.0	
103-O	103-G	550	400	220	1.2	13	2.0	
104-O	104-G	650	450	270	1.2	17	2.0 (*)	
105-O	105-G	750	550	270	1.6	27	2.0 (*)	
105A-O	105A-G	850	650	270	1.6	35	2.0 (*)	
106-O	106-G	950	700	270	1.6	41	2.0 (*)	
107-O	107-G	1 150	850	270	1.6	56	2.0 (*)	



PERANO - WALL MOUNT METAL ENCLOSURES - 3CR12 (FERRIC STAINLESS STEEL)

3CR12 ENCLOSURES - IP65 - NO GLAND PLATE

PART NUMBER		DIMENSIONS (mm)			MATERIAL THICKNESS (mm)	WEIGHT (Kg)	CHASSIS THICKNESS (mm)	B26 / RAL7032
ORANGE	GREY	HEIGHT	WIDTH	DEPTH				
ME551-O	ME551-G	350	250	170	1.2	6	2.0	 
ME552-O	ME552-G	400	300	220	1.2	8	2.0	
ME553-O	ME553-G	500	400	220	1.2	11	2.0	
ME554-O	ME554-G	600	400	220	1.2	14	2.0 (*)	
ME555-O	ME555-G	600	500	220	1.2	16	2.0 (*)	
ME556-O	ME556-G	700	600	270	1.5	26	2.0 (*)	
ME557-O	ME557-G	800	600	270	1.5	29	2.0 (*)	
ME558-O	ME558-G	900	700	320	1.5	38	2.0 (*)	
ME559-O	ME559-G	1 000	800	320	1.5	47	2.0 (*)	

(*) – FITTED WITH TWO LOCKS

3CR12 - STAINLESS STEEL ENCLOSURES - IP66 - WITH REMOVABLE GLAND PLATE

PART NUMBER		DIMENSIONS (mm)			MATERIAL THICKNESS (mm)	WEIGHT (Kg)	CHASSIS THICKNESS (mm)	B26 / RAL7032
ORANGE	GREY	HEIGHT	WIDTH	DEPTH				
ME651-O	ME651-G	350	250	170	1.2	3	2.0	 
ME652-O	ME652-G	400	300	220	1.2	8	2.0	
ME653-O	ME653-G	500	400	220	1.2	11	2.0	
ME654-O	ME654-G	600	400	220	1.2	14	2.0 (*)	
ME655-O	ME655-G	600	500	220	1.2	16	2.0 (*)	
ME656-O	ME656-G	700	600	270	1.5	26	2.0 (*)	
ME657-O	ME657-G	800	600	270	1.5	29	2.0 (*)	
ME658-O	ME658-G	900	700	320	1.5	38	2.0 (*)	
ME659-O	ME659-G	1 000	800	320	1.5	47	2.0 (*)	

PERANO - WALL MOUNT METAL ENCLOSURES - 304 STAINLESS STEEL

304 STAINLESS STEEL ENCLOSURES - IP66 - ORANGE OR GREY

PART NUMBER		DIMENSIONS (mm)			MATERIAL THICKNESS (mm)	WEIGHT (Kg)	CHASSIS THICKNESS (mm)	B26 / RAL7032
ORANGE	GREY	HEIGHT	WIDTH	DEPTH				
ME3041-O	ME3041-G	350	250	170	1.2	6	2.0	
ME3042-O	ME3042-G	400	300	220	1.2	8	2.0	
ME3043-O	ME3043-G	500	400	220	1.2	11	2.0	
ME3044-O	ME3044-G	600	400	220	1.2	14	2.0 (*)	
ME3045-O	ME3045-G	600	500	220	1.2	16	2.0 (*)	
ME3046-O	ME3046-G	700	600	270	1.5	26	2.0 (*)	
ME3047-O	ME3047-G	800	600	270	1.5	29	2.0 (*)	
ME3048-O	ME3048-G	900	700	320	1.5	38	2.0 (*)	
ME3049-O	ME3049-G	1 000	800	320	1.5	47	2.0 (*)	

(*) – FITTED WITH TWO LOCKS

304 STAINLESS STEEL ENCLOSURES - IP66 - BRUSHED FINISH (NATURAL)

PART NUMBER		DIMENSIONS (mm)			MATERIAL THICKNESS (mm)	WEIGHT (Kg)	CHASSIS THICKNESS (mm)	304
		HEIGHT	WIDTH	DEPTH				
ME3041-B		350	250	170	1.2	3	2.0	
ME3042-B		400	300	220	1.2	8	2.0	
ME3043-B		500	400	220	1.2	11	2.0	
ME3044-B		600	400	220	1.2	14	2.0 (*)	
ME3045-B		600	500	220	1.2	16	2.0 (*)	
ME3046-B		700	600	270	1.5	26	2.0 (*)	
ME3047-B		800	600	270	1.5	29	2.0 (*)	
ME3048-B		900	700	320	1.5	38	2.0 (*)	
ME3049-B		1 000	800	320	1.5	47	2.0 (*)	

PERANO - WALL MOUNT METAL ENCLOSURES - 316 STAINLESS STEEL

316 STAINLESS STEEL ENCLOSURES - IP66 - ORANGE OR GREY

PART NUMBER		DIMENSIONS (mm)			MATERIAL THICKNESS (mm)	WEIGHT (Kg)	CHASSIS THICKNESS (mm)	316
ORANGE	GREY	HEIGHT	WIDTH	DEPTH				
ME3161-O	ME3161-G	350	250	170	1.2	6	2.0	
ME3162-O	ME3162-G	400	300	220	1.2	8	2.0	
ME3163-O	ME3163-G	500	400	220	1.2	11	2.0	
ME3164-O	ME3164-G	600	400	220	1.2	14	2.0 (*)	
ME3165-O	ME3165-G	600	500	220	1.2	16	2.0 (*)	
ME3166-O	ME3166-G	700	600	270	1.5	26	2.0 (*)	
ME3167-O	ME3167-G	800	600	270	1.5	29	2.0 (*)	
ME3168-O	ME3168-G	900	700	320	1.5	38	2.0 (*)	
ME3169-O	ME3169-G	1 000	800	320	1.5	47	2.0 (*)	

(*) – FITTED WITH TWO LOCKS

316 STAINLESS STEEL ENCLOSURES - IP66 - BRUSHED FINISH (NATURAL)

PART NUMBER		DIMENSIONS (mm)			MATERIAL THICKNESS (mm)	WEIGHT (Kg)	CHASSIS THICKNESS (mm)	316
		HEIGHT	WIDTH	DEPTH				
ME3161-B		350	250	170	1.2	3	2.0	
ME3162-B		400	300	220	1.2	8	2.0	
ME3163-B		500	400	220	1.2	11	2.0	
ME3164-B		600	400	220	1.2	14	2.0	
ME3165-B		600	500	220	1.2	16	2.0 (*)	
ME3166-B		700	600	270	1.5	26	2.0 (*)	
ME3167-B		800	600	270	1.5	29	2.0 (*)	
ME3168-B		900	700	320	1.5	38	2.0 (*)	
ME3169-B		1 000	800	320	1.5	47	2.0 (*)	

ENCLOSURE ACCESSORIES

CHROME HANDLES



- BRIGHT MILD STEEL
- SUPPLIED WITH SCREWS
- AVAILABLE IN :
101-0041 : 50mm
101-0042 : 75mm
101-0043 : 100mm
101-0044 : 115mm
101-0045 : 200mm

PAINTED BLACK HANDLES



- POWDER COATED MILD STEEL
- SUPPLIED WITH SCREWS
- AVAILABLE IN :
101-0051 : 50mm
101-0052 : 75mm
101-0053 : 100mm
101-0054 : 115mm
101-0055 : 200mm

RECESSED / CHEST HANDLE



- 101-0120B
- 101-0120G
- POLYAMIDE MATERIAL
- IN BLACK OR GREY

HEAVY DUTY FOLDING RECESSED / CHEST HANDLE



- 101-0140
- ZINC DIE CAST BODY
- BLACK POWDER COATED
- STAINLESS STEEL HANDLE

T-HINGE



- 101-0145 (HEAVY DUTY)
- 101-0182 (FLUSH MOUNT)

HINGE



- 101-0168
- 52 x 40mm
- ZINC DIE CAST
- POWDER COATED BLACK

PEDESTAL HINGE



- 101-0071 (30mm)
- 101-0073 (50mm)
- 101-0075 (70mm)
- ZINC DIE CAST W/ M6 HOLES
- POWDER COATED BLACK

BRASS PEDESTAL HINGE



- 101-0176
- 100mm
- BRIGHT FINISH
- WITH M8 SCREWS

DIES CAST BLACK PEDESTAL HINGES



- 101-0126 (60mm)
- 101-0125 (75mm)
- ZINC DIES CAST
- POWDER COATED BLACK
- WITH M6 STUDS

SPRING LOADED CONCEALED HINGE



- 101-0122
- LIFT-OFF HINGE

ENCLOSURE ACCESSORIES

CONCEALED BULLET HINGE



- 101-0077
- 44 and 75mm LONG
- WELD-ON MILD STEEL
- BRASS PIN

WELD / SCREW DOWN HINGE



- 101-01-50-SS
- 101-01-27-SS
- 8 OPTIONS AVAILABLE

CUSTOM PANELS & ENCLOSURES

PERANO / WPP MANUFACTURES AND SUPPLIES
ANY CUSTOM ELECTRICAL PANELS,
ENCLOSURES, CONSOLS OR DESK.

IN ADDITION...
THEY CAN ALSO POPULATE & WIRE TO YOUR DESIGN.

TRIANGLE KEY LOCKS



- 20-1-373-01 (35mm) [8mm]
- 20-1-603-01 (50mm) [8mm]
- 20-1-373-04 (52mm) [8mm]
- 20-1-603-04 (63mm) [8mm]
- 20-1-373-05 (52mm) [8mm]
- 20-1-603-05 (63mm) [8mm]
- 20-1-373-06 (42mm) [8mm]
- 20-1-603-06 (55mm) [8mm]
- NYLON or ZINC CAMS
- 6mm / 8mm SQUARE KEY

COIN CATCH LOCK



- 8-5-271-03
METAL CAM, 22mm DEEP
- 8-5-371-03
METAL CAM, 32mm DEEP
- 8-5-271-01
POLYAMID CAM, 22mm DEEP
- 8-5-371-01
POLYAMID CAM, 32mm DEEP

TONGUES / CAMS



- P01 – P09
- NYLON / POLYAMIDE
- ZINC
- MILD STEEL
- FOR :
8, 16, 20, 24 AND 25 SERIES

DOUBLE-BIT KEY PANEL LOCK



- 25-65-404-01
- IP65
- SELECT CAM / TONGUE

KNOB HANDLE LOCKS



- 20-6-331-01 (19mm)
- 20-6-561-01 (42mm)
- 20-6-331-04 (36mm)
- 20-6-561-04 (59mm)
- 20-6-331-05 (43mm)
- 20-6-561-05 (59mm)
- ZINC DIE CAST
- 13 OPTIONS AVAILABLE

DOUBLE ACTION LOCKS



- 20-8-521
- 6 LEVER OPTIONS
- ZINC DIE CAST
- BLACK POWDER COATED

MINI LEVER LOCKS



- 20.7331.01
- 12 LEVER OPTIONS
- ZINC DIE CAST
- BLACK POWDER COATED

ENCLOSURE ACCESSORIES

HEAVY DUTY SUBSTATION LOCK



- 101-0175-SST
- 304 STAINLESS STEEL
- BRIGHT FINISH
- 110mm

CAM LOCK



- 101-0106-11 / 16
- KEYED ALIKE OR DIFF.
- OR 16mm 20. 25. 30 DEEP.
- BRIGHT FINISH

PADLOCKABLE STAINLESS STEEL LOCKS



- 200-3242-S/S
- 304 STAINLESS STEEL
- 6mm KEY

3 PADLOCKABLE STAINLESS STEEL LOCKS



- 200-3742-S/S
- 304 STAINLESS STEEL
- 10mm LOCK HOLE

PADLOCKABLE STAINLESS STEEL HANDLE



- 200-3241-S/S
- 304 STAINLESS STEEL

IP65 6mm KEY STAINLESS-STEEL LOCK



- 25-65-401-.1-S/S

DOUBLE BIT STAINLESS-STEEL LOCK



- 25-65-404-01-S/S

WING KNOB PADLOCKABLE LOCK



- 24-4-421-01
- 6 LEVEL OPTIONS
- ZINC DIE CAST
- BLACK POWDER COATED

SQUARE KEY LOCKS WITH PADLOCKABLE INTERLOCK



- 16-3-401-01 (25mm)
- 16-3-531-01 (39mm)
- 16-3-401-03 (34mm)
- 16-3-531-03 (39mm)
- 16-3-401-04 (42mm)
- 16-3-531-04 (53mm)
- NYLON or ZINC TONGUE
12 OPTIONS AVAILABLE
- 6mm SQUARE KEY

SQUARE KEY LOCKS



- 16-1-...
- 20-1-351-05 (40mm) [6mm]
- 20-1-551-05 (54mm) [6mm]
- 20-1-372-01 (55mm) [8mm]
- 20-1-372-01 (30mm) [8mm]
- NYLON or ZINC CAM
30 OPTIONS AVAILABLE
- 6mm / 8mm SQUARE KEY

ENCLOSURE ACCESSORIES

CAMS / TONGUES

WE STOCK A VARIETY OF CAMS / TONGUES
IN PLASTIC, DIES CAST, MILD STEEL
AND STAINLESS STEEL

PERANOLOC SAFETY LOCK



- 200.0712
- TAKES UP TO 6 PAD LOCKS

MASTER PANEL KEY



- PER-4-ULTRA
- ORANGE
- HEX, TRIANGLE, SQUARE & DOUBLE BIT

KEY 6mm SQR



- 6-1-12-2
POLYCARBONATE / PLASTIC
- 6-1-12-1
ZINC DIES CAST

KEY 6mm SQR



- 6mm SQUARE

KEY 8mm SQR



- 8-2-135-1
- ZINC DIE CAST

KEY 8mm TRIANGULAR



- ZINC DIE CAST
- 8-3-135-1

DOUBLE-BIT KEY



- 9-4-14-1
- ZINC DIE CAST

QUALITY ENCLOSURES

PERANO

MANUFACTURED BY :



ENCLOSURE ACCESSORIES

CYLINDER SWING HANDLE LOCK (KEY)



- 101-1107
- 142mm TALL
- IDEAL FOR 19" AND OTHER CABINETS

PADLOCKABLE SWING HANDLE LOCK



- 101-1108
- 142mm TALL
- IDEAL FOR 19" AND OTHER CABINETS

PADLOCKABLE LEVER LOCKS



- 16-4-431-04 (47mm) [ZINC]
- 16-4-431-06 (37mm) [STEEL]
- 105mm TALL
- 30 OPTIONS AVAILABLE
- ZINC DIE CAST
- BLACK POWDER COATED

COVERED PANEL LOCK



- 200-4058-MS
- 200-4058-SS
- MILD STEEL (PLATED)
- STAINLESS STEEL

FLAT BAR 3-POINT LOCKING SYSTEMS



- 101-0110 TO 0115
- 200 TO 1,000mm
- 11mm FLAT BARS & GUIDES
- LEVER PLATES & FASTENERS

ROUND BAR 3-POINT LOCKING SYSTEMS



- 101-0130 TO 0135
- 200 TO 1,000mm
- 8mm RODS & GUIDES
- LEVER PLATES & FASTENERS

PERANO PANEL LABEL HOLDERS



- SCREW ON
- 120 x 20mm OPENING

19-INCH FLOOR AND WALL RACK CABINETS



DOCUMENT HOLDER / POCKET



- PLASTIC
- VARIOUS SIZES AVAILABLE

RELATED PRODUCTS

COOLING FANS



PLASTIC FAN GUARDS



METAL FAN GUARDS

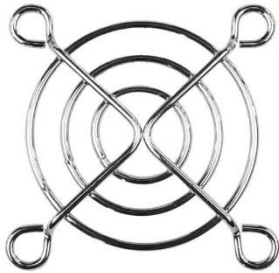

METAL FAN FILTER



FAN FILTERS



COMPRESSION GLANDS



FAN LOUVRES



CABLE TIES



BREATHER PORT



RUBBER GROMMETS





www.swan-electric.co.za

WE DO NOT HAVE A MINIMUM ORDER QTY OR VALUE
WE DELIVER TO ANY LOCATION, AT ORDINARY COURIER FEES
IF WE DO NOT HAVE IT... WE WILL SOURCE IT FOR YOU



OUR LATEST CATALOGUE

SWAN ELECTRIC IS A MOBICON COMPANY

CITY	TEL	EMAIL
CAPE TOWN	+27 21 555 0644	sales@swan-electric.co.za
DURBAN	+27 31 206 2783	
JOHANNESBURG	+27 11 493 9307	
MIDRAND	+27 11 314 0202	
PORT ELIZABETH	+27 41 364 1893	