

CBB61

AC MOTOR CAPACITOR

- 1 CBB61 is specially for electric fan motor, such as table fan motor, standing fan motor, Electric water pump and other electric motor.
- 2 We have different terminals, such as copper pins, CP wire and plastic coated copper wire.

THE SPECIFICATION CAN BE ACCORDING TO YOUR REQUIREMENTS.

ALWAYS SOME SECTION SUITS YOU

DINGFENG

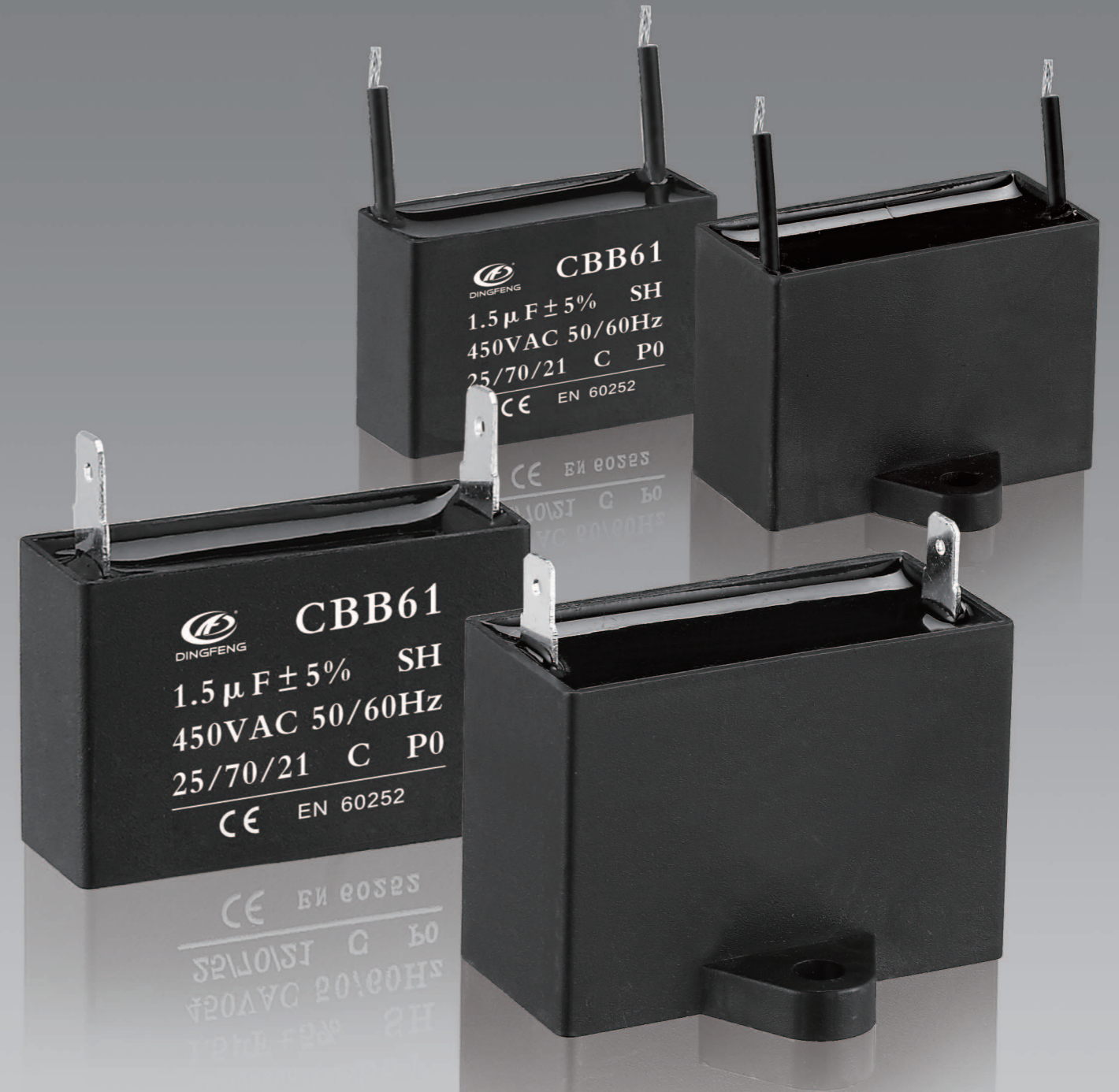

ALWAYS ON THE WAY TO BE BETTER

TAIZHOU DINGFENG ELECTRIC APPLIANCE CO., LTD.

Product Anatomy

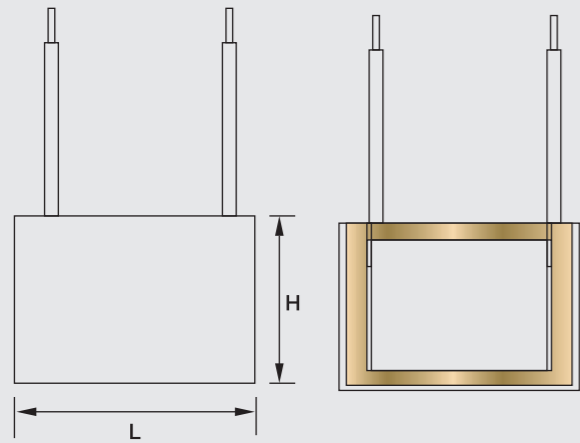
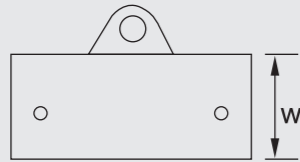

CBB61

None induction winding structure of metallic polypropylene membrane. Use square plastic shell, and insulation sealed lid for sealing, plastic lid for sealing or resin for sealing.

Small volume, light weight, low loss, excellent self-healing performance. Copper soldering terminal, plastic coated copper wire and CP wire are available.

With its good self-healing characteristic, long-life span and high proportionality, it is widely used as the start-up and running capacitor. That is specially for electric fan, air-conditioner, electric water pump and electric motor etc.

With frequency 50/60Hz, voltage 250VAC, and can help motors start and run.

It can continuously operate under rated conditions

Main technical parameter

Working Temperature Range:	40-- +70°C
Rated Voltage Range:	200-500Vac
Rated Capacitance Range:	1-30MFD
Dissipation Factor:	Tan \leq 0.002 (50Hz)
Rated Tolerance of capacitance:	\pm 5%
Withstand voltage:	intensity Pole-pole Rated voltage \times 2/10s Pole-Shell \times 2+1000V Min 2000V.AC Insulation resistance T-T RC \geq 4000S
Reference standard:	EN 60252

Product Anatomy

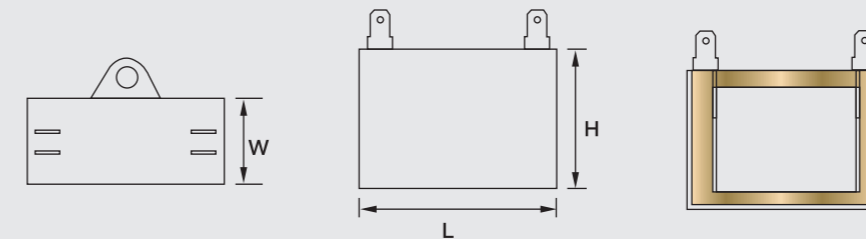
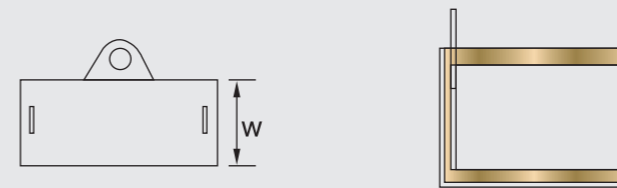
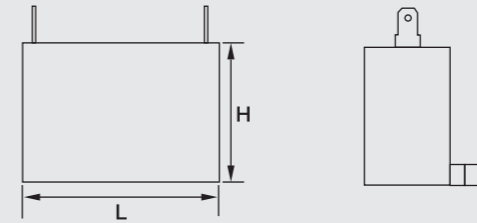

★ Back



CBB61-C

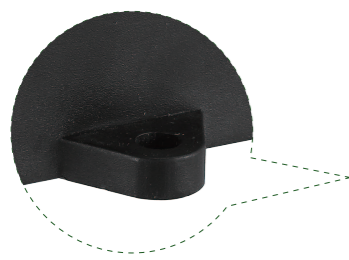

★ Back



CBB61-A



CBB61-B

Fan capacitor capacitor Dimensions:

MFD	450VAC			250VAC		
	L(mm)	W(mm)	H(mm)	L(mm)	W(mm)	H(mm)
1MFD	36	11	22	37	15	26
1.5MFD	38	13.5	24	37	15	26
2MFD	38	15	25	38	15	26
3MFD	38	15	25	37	15	30
5MFD	47	20.5	33	37	16	30
8MFD	48	22	35	47	17	32
10MFD	47	23	35	47	17	33
12MFD	58	25	38	47	21	45
15MFD	59	28	40	59	29	53
18MFD	59	30	40	59	29	53
20MFD	59	30	40	59	29	53
25MFD				59	29	53
30MFD				59	29	53



CBB61-D