

AG7

ZERO MERCURY

Alkaline Button Cell



Dimensions

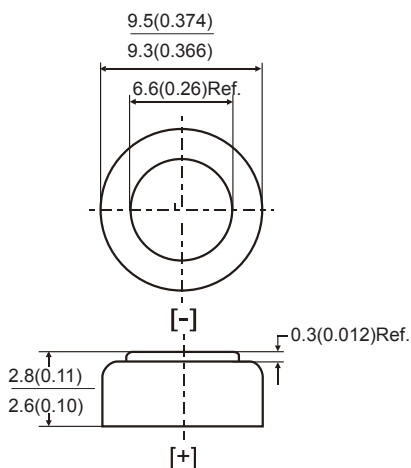

Unit:mm(inch)

Specifications

Chemical System:	Alkaline(Zn/MnO ₂) (Zinc-Manganese Dioxide)
IEC Name:	LR57
Camelion Model:	AG7(LR926)
Average Weight:	0.7g
Dimension(ΦxH)	9.4 x 2.7mm 0.37x 0.11 inch
Terminals:	Flat
Nominal Voltage:	1.5Volts
Capacity:	45mAh (Rated at 15kohm to 0.9V)
Operating Temperature:	-18°C -55°C
Storage Temperature:	15°C -25°C
Relative Humidity:	60±15%

Usage Guide



Watch



Calliper



Calculator

Typical Discharge Testing

Typical characteristics at 21 °C

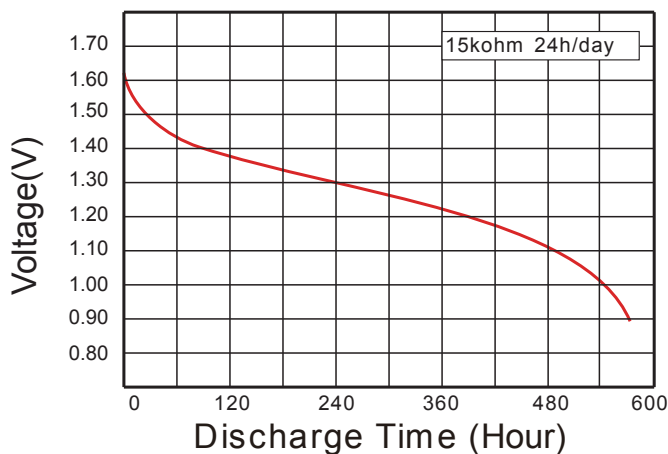

Notice:

Environmental elements comply with 2006/66/EC and US LAW 104-142 requirements. This data sheet is typical information specific to products manufactured at the time of its publication. Contact Camelion Battery Co., Ltd. for the latest information.