

# UNI-T®

## UT71

Intelligent  
Digital Multimeters



P/N: 110401103946

**UNI-T®**

**Model UT71A/B/C/D/E  
OPERATING MANUAL**



## TABLE OF CONTENTS

CHAPTER	TITLE	PAGE
<b>1.</b>	<b>Before You Start</b> -----	5
	Overview -----	5
	Unpacking Inspection -----	6
	Safety Information -----	7
	Rules For Safe Operation -----	7
	International Electrical Symbols -----	9
<b>2.</b>	<b>Getting Acquainted</b> -----	10
	Turning the Meter On -----	10
	Battery Considerations -----	10
	Automatic Power Off -----	10
	Automatic Backlight Off -----	10
	Low Battery Indication -----	11
	The Meter Structure -----	11
	Rotary Switch -----	12
	Functional Buttons -----	15
	The Meter Functions Vs Displays -----	21
	Selecting the Range -----	24
	Understanding the Display -----	24

CHAPTER	TITLE	PAGE
	Analogue Bar Graph .....	29
	Using MAX MIN .....	29
<b>3.</b>	<b>Making Measurements</b> .....	<b>30</b>
	Introduction .....	30
	A. Measuring Voltages .....	30
	B. Measuring Currents .....	32
	C. Measuring Resistance .....	34
	D. Testing for Continuity .....	35
	E. Testing Diodes .....	37
	F. Measuring Capacitance .....	39
	G. Measuring Frequency / Duty Cycle .....	41
	H. Measuring Temperature .....	43
	I. 4~20mA loop current as % readout .....	44
	J. Power Measurement .....	45
<b>4.</b>	<b>Using Stores, Recall and Send Features</b> .....	<b>47</b>
	Introduction .....	47
	Storing and Clearing Readings .....	47
	Recalling Stored Readings .....	48
	Using Send .....	48

CHAPTER	TITLE	PAGE
<b>5.</b>	<b>Changing the Default Setting</b> -----	49
	Introduction -----	49
	Selecting Setup Options -----	49
<b>6.</b>	<b>Maintenance</b> -----	52
	A. General Service -----	52
	B. Replacing the Fuses -----	53
	C. Replacing the Battery -----	54
<b>7.</b>	<b>Specifications</b> -----	55
	Safety and Compliances -----	55
	Physical Specifications -----	56
	General Specifications -----	57
	Feature Summary -----	58
	Basic Specifications -----	59
	Detailed Accuracy Specifications -----	60
	A. DC Voltage -----	60
	B. AC Voltage -----	61
	C. DC Current -----	63
	D. AC Current -----	64

CHAPTER	TITLE	PAGE
	E. Resistance -----	65
	F. Continuity Test -----	65
	G. Diode Test -----	66
	H. Capacitance -----	66
	I. Frequency -----	67
	J. Temperature Degrees Celsius Fahrenheit -----	68
	K. 4~20mA loop current -----	69
	L. Power Measurement -----	69

## Chapter 1 Before You Start

### Overview

This Operating Manual covers information on safety and cautions. Please read the relevant information carefully and observe all the **Warnings** and **Notes** strictly.



#### Warning

**To avoid electric shock or personal injury, read the "Safety Information" and "Rules for Safe Operation" carefully before using the Meter.**

Digital Multimeter **UT71A/B** (hereafter referred to as "the Meter") is a 20000 counts and 4 1/2 digits with steady operations; Digital Multimeter **UT71C/D/E** (hereafter referred to as "the Meter") is a 40000 counts and 4 3/4 digits with steady operations, fashionable structure and auto ranging instrument. They all not only can measure AC voltage and current, DC voltage and current, Resistance, Capacitance, Temperature, Frequency, Diodes, Continuity, 4~20mA Loop, Max/Min, Relative Mode but also has Data Store, Data Recall, AC True RMS, AC+DC, Low Battery Display, Double Display Backlight, Data Hold, Automatic Power Off and full overload protection.

**UT71B/C/D/E** has extra Temperature, 4~20mA Loop, Data Store and Data Recall feature; **UT71E** has extra Power Measurement feature.



## Unpacking Inspection

Open the package case and take out the Meter. Check the items shown on Table 1-1 carefully to see any missing or damaged part:

Table 1-1. Unpacking Inspection

Item	Description	Qty
1	English Operating Manual	1 piece
2	Test Lead	1 pair
3	K-Type (nickel chromium ~ nickel silicon) Point Contact Temperature Probe (It is only suitable for measuring temperature under 230 oC)	1 piece
4	Alligator Clip	1 piece
5	Test Clip	1 pair
6	USB interface cable	1 piece
7	CD-ROM (Installation Guide & Computer Interface Software)	1 piece
8	Carrying Bag	1 piece
9	Power Adaptor (UT71E only)	1 piece
10	9V Battery (NEDA 1604, 6F22, 006P)	1 piece

In the event you find any missing or damage, please contact your dealer immediately.

### Safety Information

This Meter complies with the standards IEC61010 safety measurement requirement: in pollution degree 2, overvoltage category (CAT. III 1000V, CAT.IV 600V) and double insulation.

CAT. III: Distribution level, fixed installation, with smaller transient overvoltage than CAT. IV

CAT.IV: Primary supply level, overhead lines, cable systems etc.

Use the Meter only as specified in this operating manual, otherwise the protection provided by the Meter may be impaired.

In this manual, a Warning identifies conditions and actions that may pose hazards to the user, or may damage the Meter or the equipment under test.

A Note identifies the information that user should pay attention to.


International electrical symbols used on the Meter and in this Operating Manual are explained on page 9.

### Rules For Safe Operation

#### Warning

To avoid possible electric shock or personal injury, and to avoid possible damage to the Meter or to the equipment under test, adhere to the following rules:









- 1 Before using the Meter inspect the case. Do not use the Meter if it is damaged or the case (or part of the case) is removed. Look for cracks or missing plastic. Pay attention to the insulation around the connectors.
- 1 Inspect the test leads for damaged insulation or exposed metal. Check the test leads for continuity. Replace damaged test leads with identical model number or electrical specifications before using the Meter.
- 1 Do not apply more than the rated voltage, as marked on the Meter, between the terminals or between any terminal and grounding.
- 1 The rotary switch should be placed in the right position and no any changeover of range shall be made during measurement is conducted to prevent damage of the Meter.

- 1 When the Meter working at an effective voltage over 60V in DC or 30V rms in AC, special care should be taken for there is danger of electric shock.
- 1 Use the proper terminals, function, and range for your measurements.
- 1 If the value to be measured is unknown, use the maximum measurement position.
- 1 Do not use or store the Meter in an environment of high temperature, humidity, explosive, inflammable and strong magnetic field. The performance of the Meter may deteriorate after dampened.
- 1 When using the test leads, keep your fingers behind the finger guards.
- 1 Disconnect circuit power and discharge all high-voltage capacitors before testing resistance, continuity, diodes.
- 1 Before measuring current, check the Meter's fuses and turn off power to the circuit before connecting the Meter to the circuit.
- 1 Replace the battery as soon as the battery indicator  appears. With a low battery, the Meter might produce false readings that can lead to electric shock and personal injury.
- 1 When servicing the Meter, use only the same model number or identical electrical specifications replacement parts.
- 1 The internal circuit of the Meter shall not be altered at will to avoid damage of the Meter and any accident.
- 1 Soft cloth and mild detergent should be used to clean the surface of the Meter when servicing. No abrasive and solvent should be used to prevent the surface of the Meter from corrosion, damage and accident.
- 1 The Meter is suitable for indoor use.
- 1 Turn the Meter off when it is not in use and take out the battery when not using for a long time.
- 1 Constantly check the battery as it may leak when it has been using for some time, replace the battery as soon as leaking appears. A leaking battery will damage the Meter.

## International Electrical Symbols

Symbols used on the Meter and in this manual are explained in Table1-2.

**Table 1-2. International Electrical Symbols**

	AC or DC
	DC Measurement
	AC Measurement
	Grounding
	Double Insulated
	Warning. Refer to the Operating Manual
	Deficiency of Built-In Battery
	Conforms to Standards of European Union

## Chapter 2 Getting Acquainted

### Turning the Meter On

To turn the Meter on, turn the rotary switch from OFF to any switch setting.

### Battery Considerations

The Meter uses one 9V Battery (NEDA 1604, 6F22, 006P). The following paragraphs describe several techniques used to conserve battery power.

### Automatic Power Off

The display blanks and the Meter goes into a "sleep" mode if you have not changed the rotary switch position or pressed a button for a set period. While in Sleep mode, pressing the blue button or turning the rotary switch could turn the Meter on. The Meter then returns to the display for the function selected with the rotary switch; all previously activated button features are discarded.


The automatic power off is preset to 10 minutes. From the Setup menu (see Chapter 5), you could specify a time (10 minutes, 20 minutes, 30 minutes or OFF). If you set to OFF, the Meter retains on until you turn the rotary switch to OFF or the battery becomes too weak.

### Automatic Backlight Off


Press **LIGHT** button to turn the backlight on and press **LIGHT** again to turn it off. Press **EXIT** to exit the feature.

Press **LIGHT** to select the backlight level (low or high). In Setup menu (see Chapter 5), you could specify a time to automatically turn off the backlight (10 seconds, 20 seconds, 30 seconds or OFF). If the period is set to OFF, the backlight feature is disabled.

### Low Battery Indication

A constant battery icon (  ) in the upper left corner of the display notifies you that the batteries are low and should be replaced.

### Warning

To avoid false readings, which could lead to possible electric shock or personal injury, replace the battery as soon as the battery icon (  ) appears.

### The Meter Structure

The Figure 2-1 shows the Meter structure.

1. LCD Display
2. Functional Buttons
3. Rotary Switch
4. Input Terminals

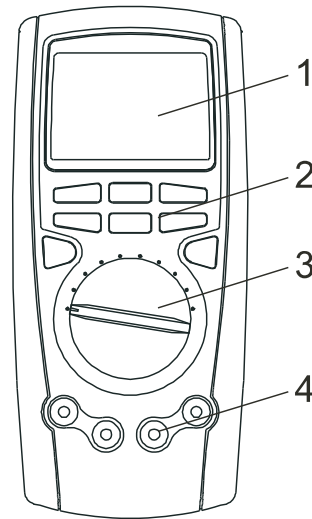


Figure 2-1. Meter Structure

## Rotary Switch

Turn the Meter on by selecting any measurement function. The Meter presents a standard display for that function. The display may also be influenced by some of the choices made in Setup.

Use the blue button to select any rotary switch alternate function (labeled in blue letters).




When you turn the rotary switch from one function to another, a display for the new function appears. Button choices made in one function do not carry over into another function.

The Table 2-1 described each rotary switch position

Table 2-1. Rotary Switch Selections

Rotary Switch Position	Rotary Switch Function	Blue Key Function
OFF	Turn the Meter off	None
V $\overline{\text{---}}$ (UT71A/B/C/D)	DC voltage measurement	None
V $\sim$ (UT71A/B/C/D)	AC voltage measurement	None
V $\overline{\sim}$ (UT71E only)	AC or DC voltage measurement	Toggle between AC or DC voltage measurement
Hz % mV $\overline{\text{---}}$ (UT71B/C/D)	DC millivoltage measurement	1 Frequency measurement 1 Frequency signal duty cycle measurement
mV $\overline{\text{---}}$ (UT71A/E)	DC millivoltage measurement	None
$\rightarrow \bullet \Omega$	Resistance measurement	1 Diode test 1 Continuity test
W (UT71E only)	Power measurement	None
$\overline{\text{---}}$	Capacitance measurement	None
$^{\circ}\text{C } ^{\circ}\text{F}$ (UT71B/C/D)	Centigrade temperature measurement	Fahrenheit temperature measurement



Rotary Switch Position	Rotary Switch Function	Blue Key Function
<b>Hz %</b> <b>C F</b> (UT71E only)	Centigrade temperature measurement	1 Fahrenheit temperature measurement 1 Frequency measurement 1 Frequency signal duty cycle measurement
<b>μA</b> 	AC or DC current measurement (400μA ,4000μA)	Toggle between AC or DC current
<b>mA</b>  <b>(4~20mA)</b> %	AC or DC current measurement (40mA ,400mA)	Toggle between AC or DC current 4~20mA loop current as % reading
<b>A</b> 	AC or DC current measurement (10A)	Toggle between AC or DC current

## Functional Buttons

The buttons activate features that augment the function selected with the rotary switch. The buttons are shown in Table 2-2.





Press the button once to access the main feature (e.g. STORE).

To access the first additional feature of the button (e.g. RECALL), press and hold the button for over 1 second to access this additional feature. This additional feature appears right above or on the left hand side of the appropriate keys.



To access the second additional feature of the button (e.g. ◀), press once the button again while the Meter has already entered the first additional feature (e.g. RECALL). The second additional feature appears on the right hand side above the appropriate keys.

The RANGE and EXIT buttons has only one additional feature.


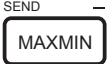
**Table 2-2. Functional Buttons**

Button	Description	Access Method
	<p>Range feature: Exit AUTO and enter MANUAL ranging. In MANUAL, select next input range. EXIT to return to AUTO. AUTO is default.</p> <p>Testing resistance signal from calibrator: When testing resistance signal from calibrator, it is necessary to press this button to change the maximum display to 4000 counts but the accuracy remains unchanged.</p> <p>Setup feature: Access Setup selections, the display shows "SET". In the Setup mode, each press of <b>SETUP</b> button steps to the next Selection</p>	<p>Press the button once.</p> <p>Press and hold the button while turning on the Meter</p> <p>Press and hold the button for more than 1 second</p>
	<p>Store feature: Store the current measurement value. Press <b>EXIT</b> to exit the Store feature.</p>	<p>Press the button once.</p>

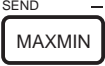


**Table 2-2. Functional Buttons**

Button	Description	Access Method
	<p>Recall feature: Recall the stored value. Press <b>EXIT</b> to exit the Recall feature.</p>	<p>Press and hold the button for over 1 second</p>
	<p>Setup feature: In Setup, press to select OFF at the selection of HIGH and LOW</p>	<p>Press the button once after entering Setup mode.</p>
	<p>Hold feature: Press <b>HOLD</b> to freeze the displayed value. Press <b>EXIT</b> to release the display.</p>	<p>Press the button once.</p>
	<p>Peak Hold feature: Press to access Peak Hold feature, the primary display shows PEAK HOLD. Press EXIT to exit.</p>	<p>Press and hold the button for over 1 second.</p>
	<ul style="list-style-type: none"> <li>1 In Setup, each press to select the digit you want to edit.</li> <li>1 In Recall, press to enable SEND feature</li> <li>1 In Store, press to toggle between clearing all the stored reading or start storing reading from the current index number.</li> </ul>	<p>Press the button once after entering Setup or Recall or Store mode.</p>




**Table 2-2. Functional Buttons**

Button	Description	Access Method
	Press to exit certain button functions and the Meter will return to the factory default setting.	Press the button once.
	Press to turn the backlight on. It is possible to toggle between 1 <sup>st</sup> and the 2 <sup>nd</sup> backlight level and Exit the feature by pressing this button. After exiting the light feature, it is necessary to press and hold the button for over 1 second to turn the backlight on again.	Press and hold the button for over 1 second.
	Press to display max, min and average values. Press <b>EXIT</b> to stop and return to current measurement mode.	Press the button once.
	Press to output the data, AUTO mode switch off. The primary display shows "SEND". Press <b>EXIT</b> to exit.	Press and hold the button for over 1 second.
	In Setup, each press to decrement an Option. In Recall, each press to go back to the previous stored reading.	Press the button once after entering SEND mode.

**Table 2-2. Functional Buttons**

Button	Description	Access Method
	<p>In Store, each press to decrease a second on the storing interval.</p> <p>Press <b>EXIT</b> to exit</p>	
	<p>Press to enter relative mode, the primary display shows <math>\Delta</math> . The left secondary display shows the present measurement value. The right secondary display shows the stored value. The primary display shows the present measurement value minus the stored value.</p> <p>Press <b>EXIT</b> to exit relative mode.</p> <p>In Setup, each press to increment an Option. In Recall, each press to recall the next stored reading. In Store, each press to increase a second on the storing interval.</p>	<p>Press the button once.</p> <p>Press and hold the button for over 1 second.</p>
 <p>(UT71A only)</p>	<p>Press to output the data, AUTO mode switch off. The primary display shows "SEND".</p> <p>Press <b>EXIT</b> to exit.</p>	<p>Press the button once.</p>




**Table 2-2. Functional Buttons**

Button	Description	Access Method
 <p>SEND (UT71A only)</p>	<p>Setup feature: In Setup, press to select OFF at the selection of HIGH and LOW</p>	<p>Press the button once after entering Setup mode.</p>
 <p>Yellow Button</p>	<p>When it is at AC measurement mode, press the button to display AC+DC True RMS value in the primary display and the left secondary display "AC+DC".</p>	<p>Press the button once</p>
 <p>Blue Button</p>	<p>Use the blue button to select any rotary switch alternate function (labeled in blue letters).</p> <p>Press and hold the Button while turning on the Meter to toggle to 4000 counts for all functions.</p> <p>It is faster when the Meter is at 4000 counts measurement mode.</p> <p>After the Meter is resuming from Automatic Power Off or turn on and off again, the Meter will back to normal measurement mode (40000 counts).</p>	<p>Press the button once</p>

## The Meter Functions Vs Displays

Table 2-3 shows the cross reference of function and display:

Table 2-3 Functions Vs Displays

Function	Primary Display	Right Secondary Display	Left Secondary Display
DCV	The tested DC voltage value	No display	Full range: 4, 40, 400, 1000
ACV	The tested AC voltage value	The tested frequency value: 45.00Hz~ 100.0kHz	Full range: 4, 40, 400, 1000
DCmV	The tested DCmV value	No display	Full range 400
$\Omega$	The tested resistance value	No display	Full range: 400, 4, 40, 400, 4, 40
	The tested resistance value	No display	Full range value: 400
	The tested resistance value	No display	Full range 4
Hz	The tested frequency value	No display	Full range: 40, 400, 4, 40, 400, 4, 40, 400
	The tested capacitance value	No display	Full range: 40, 400, 4, 40, 400, 4, 40
°C	The tested °C value	No display	1000
°F	The tested °F value	No display	1832
DC $\mu$ A	The tested DC $\mu$ A value	No display	Full range: 400, 4000



**Table 2-3 Functions Vs Displays**

<b>Function</b>	<b>Primary Display</b>	<b>Right Secondary Display</b>	<b>Left Secondary Display</b>
<b>AC<math>\mu</math>A</b>	The tested AC $\mu$ A value	The tested frequency value: 45.00Hz~10.00kHz	Full range: 400, 4000
<b>DCmA</b>	The tested DCmA value	No display	Full range: 40, 400
<b>ACmA</b>	The tested ACmA value	The tested frequency value: 45.00Hz~10.00kHz	Full range: 400, 4000
<b>DCA</b>	The tested DC current value	No display	Full range: 10
<b>ACA</b>	The tested AC current value	The tested frequency value: 45.00Hz~10.00kHz	Full range: 10
<b>W</b>	The tested power value	Apparent power value	Power factor value
<b>RCL</b>	Data recalled is on	— — — .	— — — .

**Table 2-3 Functions Vs Displays**

<b>Function</b>	<b>Primary Display</b>	<b>Right Secondary Display</b>	<b>Left Secondary Display</b>
<b>STO</b>	The recalled value	The total number of stored value.	Index number: no.0001~no.0100 (For UT71A/B/C/E) no.0001~no.9999 (For UT71D)
<b>MAX MIN</b>	Chapter 2 Getting Acquainted - Using MAX MIN		
<b>REL Δ</b>	The present measurement value minus the stored value	The stored value	The present measurement value.

## Selecting the Range

Press RANGE to select either a fixed range or the autorange feature.

Autoranging (AUTO lighted in the display) always comes on initially when you select a new function. In autorange, the Meter selects the lowest input range possible, ensuring that the reading appears with the highest available resolution.

If AUTO is already on, press RANGE to enter MANUAL ranging in the present range. You can then select the next manual range each time you press RANGE. Return to autoranging by press EXIT.

Note that there is no MANUAL ranging on REL feature.

## Understanding the Display

Display features are shown in Figure 2-2 and described in Table 2-4.

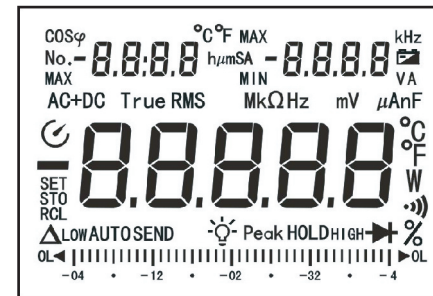




Figure 2-2. Display Features




Table 2-4. Display Features

No.	Symbol	Meaning
1	MAX	Maximum reading displayed.
	MIN	Minimum reading displayed
2	No	The sequence of the reading.
3	°C, °F	Degrees Celsius (default) or Fahrenheit.
4	—	Indicates negative reading
5		The battery is low.
		 Warning: To avoid false readings, which could lead to possible electric shock or personal injury, replace the battery as soon as the battery indicator appears.
6	SET	Setup feature is on.



**Table 2-4. Display Features**

No.	Symbol	Meaning
7	<b>TrueRMS</b>	Indicator for True RMS value.
8	<b>AC+DC</b>	For DCV and DCA functions, reading represents the True RMS total of AC and DC measurements
9	<b>Ω, kΩ, MΩ</b>	Ω: Ohm. The unit of resistance.
		kΩ:Kilohm. $1 \times 10^3$ or 1000 ohms
		MΩ:Megaohm. $1 \times 10^6$ or 1,000,000 ohms
	<b>Hz, kHz, MHz</b>	Hz : Hertz. The unit of frequency in cycles/second.
		kHz: Kilohertz. $1 \times 10^3$ or 1000 hertz
		MHz: Megahertz, $1 \times 10^6$ or 1,000,000 hertz.
	<b>mV, V</b>	V: Volts. The unit of voltage.
		mV: Millivolt. $1 \times 10^{-3}$ or 0.001 volts
	<b>μA, mA, A</b>	A: Amperes (amps). The unit of current.
mA: Milliamp, $1 \times 10^{-3}$ or 0.001 amperes.		
μA:Microamp. $1 \times 10^{-6}$ or 0.000001 amperes.		

**Table 2-4. Display Features**

No.	Symbol	Meaning
9	nF,μF, mF	Farad. The unit of capacitance
		nF: Nanofarad. $1 \times 10^{-9}$ or 0.000000001 farads.
		μF: Microfarad. $1 \times 10^{-6}$ or 0.000001 farads.
		mF: Millifarad. $1 \times 10^{-3}$ or 0.001 farads.
10		Automatic power off feature is on
11		Continuity test
12	<b>STO</b>	Data store is on
	<b>RCL</b>	Data recall is on
13		The relative mode is on to display the present value minus the stored value.
14	<b>LOW</b>	The indicator for the lowest setup limit.
	<b>HIGH</b>	The indicator for the highest setup limit.
15	<b>AUTO</b>	The Meter is in the auto range mode in which the Meter automatically selects the range with the best resolution.
16	<b>SEND</b>	Data output is in progress

**Table 2-4. Display Features**

No.	Symbol	Meaning
17		Backlight feature is on
18	<b>HOLD</b>	Data hold mode is active
19	<b>PEAK HOLD</b>	Peak hold mode is active
20		Diode test
21	%	l Frequency signal duty cycle.
		l 4~20mA loop current as % reading
22	<b>▶ OL</b>	The input value is too large for the selected range.
23	<b>Analogue Bar Graph</b>	Provides an analog indication of the present input, quick response.
24	<b>COS <math>\phi</math></b>	Indicator of power factor.
25	<b>VA</b>	Indicator of apparent power unit.
26	<b>W</b>	Indicator of power measurement

## Analogue Bar Graph

The bar graph provides an analogue indication of the measured input. For most measurement functions, the bar graph updates 10 times per second.

## Using MAX MIN

The MAX MIN mode stores minimum (MIN) and maximum (MAX) input values. When the input goes below the stored minimum value or above the stored maximum value, the Meter beeps and stores the new value.

Press **MAX MIN** to enter MAX MIN mode. The sampling time is every 2 seconds. The maximum reading and MAX are shown on the left secondary display. The minimum reading and MIN are shown on the right secondary display. The primary display shows the current measurement reading.

Press MAX MIN the second time, the current measurement reading is shown on the left secondary display. The minimum reading and MIN are shown on

the right secondary display. The primary display shows the maximum value.

Press MAX MIN the third time, the current measurement reading is shown on the left secondary display. The maximum reading and MAX are shown on the right secondary display. The primary display shows the minimum value.

Each subsequent press of **MAX MIN** steps through the above three modes.

To exit MAX MIN mode, press **EXIT**.

Press **HOLD** to stop the Meter updating reading.

MAX MIN mode can only be used under MANUAL ranging mode.



## Chapter 3 Making Measurement

### Introduction

Chapter 3 explains how to make measurements. Most measurement functions can be selected by using the rotary switch.

While letters or symbols identify primary functions; blue letters or symbols identify alternative functions. Press the **BLUE** button to access these alternate functions.

### A. Measuring Voltages



#### Warning

To avoid harms to you or damages to the Meter from electric shock, please do not attempt to measure voltages higher than 1000V, although readings may be obtained.

To measure voltages, set up the Meter as Figure 3-1 and do the following:

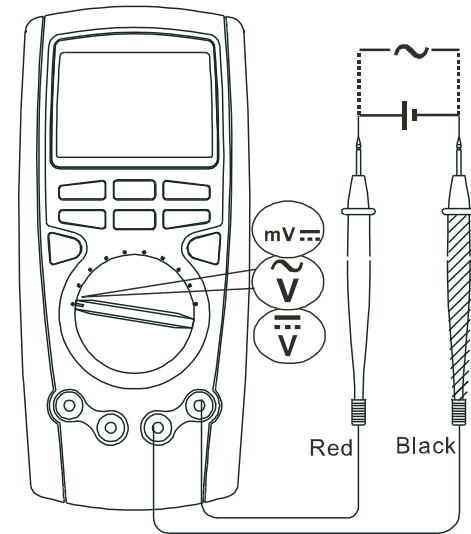


Figure 3-1. Voltages Measurement

1. Insert the red test lead into the **V** terminal and the black test lead into the **COM** terminal.
2. Set the rotary switch to  $\overline{\text{V}}$  or  $\tilde{\text{V}}$  or  $\frac{\text{Hz}\%}{\text{mV}}$  ;  
Set the rotary switch to or  $\text{V}$  or  $\text{mV}$  (UT71E).  
The default is DC voltage measurement, press BLUE button to switch to AC voltage measurement mode.
3. Connect the test leads across with the object being measured.
4. The measured value shows on the display.  
AC measurement displays the True RMS value.  
DC measurement displays the effective value of sine wave (mean value response).

When a ACV function is selected, you can press the **Yellow Button** to view the AC + DC True RMS value in the primary display. To exit, please **EXIT** button.

The **BLUE** button cycles among  $\text{mV}$ , frequency and duty cycle.

### Note

- 1 When measuring voltage, the Meter acts around a  $10\text{M}\Omega$  ( $\overline{\text{V}}$  and  $\tilde{\text{V}}$ ) or  $2.5\text{G}\Omega$  ( $\text{mV}$ ) impedance in parallel with the circuit. This loading effect can cause measurement errors in high impedance circuits. In most cases, the error is negligible (0.1% or less) if the circuit impedance is  $10\text{k}\Omega$  or less.
- 1 Special care should be taken when measuring high voltage.
- 1 When voltage measurement has been completed, disconnect the connection between the testing leads and the circuit under test and remove testing leads away from the input terminals of the Meter.

### B. Measuring Currents

#### Warning

If the fuse burns out during measurement, the Meter may be damaged or the operator himself may be hurt.

To avoid possible damage to the Meter or to the equipment under test, check the Meter's fuses before measuring current. Use proper terminals, function, and range for the measurement. Never place the testing leads in parallel with any circuit or component when the leads are plugged into the current terminals.

To measure AC or DC current, set up the Meter as Figure 3-2 and proceed as follows:

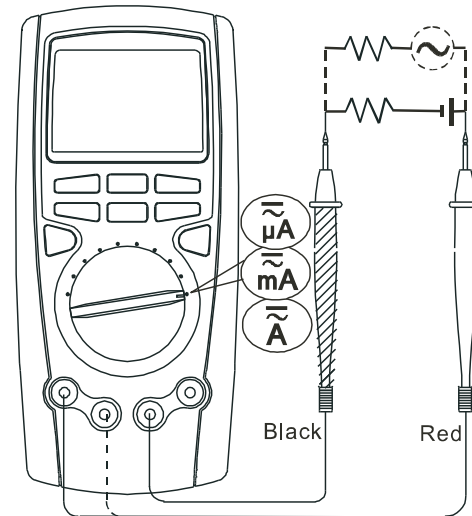


Figure 3-2. Currents Measurement

1. Turn off power to the circuit. Discharge all high-voltage capacitors.
2. Insert the red test lead into the **mA $\mu$ A** or **A** terminal and black test lead into the **COM** terminal.
3. If you are using the **A** terminal, set the rotary switch to **A $\sim$** . If you are using **mA $\mu$ A** terminal, set the rotary switch to  **$\mu$ A $\sim$**  for currents below 40000 $\mu$ A (UT71A is 20000 $\mu$ A), or **mA $\sim$**  for current above 40000 $\mu$ A (UT71B is 20000 $\mu$ A).
4. DC measurement is default, press **blue button** to select AC measurement.
5. Open the circuit path to be tested. Touch the red testing leads to the more positive side of the break; touch the black probe to the more negative side of the bread. Reversing the leads will produce a negative reading, but will not damage the Meter.
6. Turn on power to the circuit; then read the display. AC measurement displays the True RMS value. DC measurement displays the effective value of sine wave (mean value response)
7. Turn off power to the circuit and discharge all high-voltage capacitors. Remove the Meter and restore

When a ACA function is selected, you can press the **Yellow Button** to view the AC + DC True RMS value in the primary display. To exit, please **EXIT** button.

### Note

- 1 If the value to be measured is unknown, use the maximum measurement position and reduce the range step by step until a satisfactory reading is obtained.
- 1 When the measured current is  $\leq 5A$ , continuous measurement is allowed.
- 1 When the measured current is between 5A-10A, continuous measurement  $\leq 10$  seconds and interval more than 15 minutes.
- 1 When current measurement has been completed, disconnect the connection between the testing leads and the circuit under test and remove testing leads away from the input terminals of the Meter.



### C. Measuring Resistance

#### Warning

To avoid harms to you, please do not attempt to input voltage higher than 60V DC or 30V rms AC.

To avoid possible damages to the Meter or to the devices under test, disconnect circuit power and discharge all the high-voltage capacitors before measuring resistance.

To measure resistance, set up the Meter as shown in Figure 3-3 and follow the following procedure:

1. Insert the red test lead into the  $\Omega$  terminal and the black test lead into the **COM** terminal.
2. Set the rotary switch to  $\Omega$   ; press **BLUE** button to select  $\Omega$  measurement mode.
3. Connect the test leads across with the object being measured.

The measured value shows on the display.

The **BLUE** button cycles among resistance, continuity, and diode.

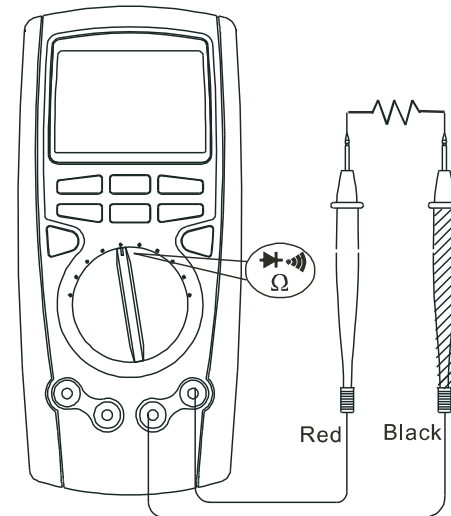


Figure 3-3. Resistance Measurement

**Note**

- 1 When measuring low resistance, the test leads can add  $0.1\Omega$  to  $0.2\Omega$  of error to resistance measurement. To test the leads, touch the probe tips together and read the resistance of the leads. If necessary, you can press **REL**  $\Delta$  to automatically subtract this value.
- 1 For high-resistance measurement ( $>1M\Omega$ ), it is normal taking several seconds to obtain a stable reading. In order to obtain precision readings, use the test lead as short as possible.
- 1 The LCD displays **OL** indicating open-circuit or the tested resistor value is higher than the maximum range of the Meter.
- 1 When testing the resistance signal from the calibrator, it is necessary to press and hold the **RANGE** while turning on the Meter to change the maximum display to 4000 counts but the accuracy remains unchanged.
- 1 When resistance measurement has been completed, disconnect the connection between the testing leads and the circuit under test and remove testing leads away from the input terminals.

**D. Testing for Continuity**** Warning**

To avoid harms to you, please do not attempt to input voltage higher than 60V DC or 30V rms AC.

To avoid possible damages to the Meter or to the devices under test, disconnect circuit power and discharge all the high-voltage capacitors before measuring continuity.

To test for continuity, set up the Meter as Figure 3-4 and do the following:

1. Insert the red test lead into the  $\Omega$  terminal and the black test lead into the **COM** terminal.
2. Set the rotary switch to  $\Omega$   $\bullet$ )  $\rightarrow$ ; press **BLUE** button to select  $\bullet$ ) measurement mode and connect the test leads across with the object being tested.
3. The beeper comes on continuously for open conditions, that is test resistance  $\leq 50\Omega$ .

The **BLUE** button cycles among resistance, continuity, and diode.

### Note

- 1 Open circuit voltage around -1.2V and range is 400  $\Omega$  measurement range.
- 1 When continuity testing has been completed, disconnect the connection between the testing leads and the circuit under test and remove the test leads away from the input terminals.

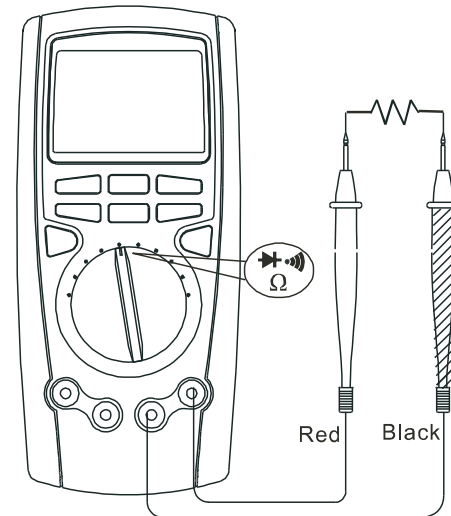


Figure 3-4. Continuity Test

### E. Testing Diodes



#### Warning

To avoid harms to you, please do not attempt to input voltages higher than 60V DC or 30V rms AC.

To avoid damages to the Meter or to the devices under test, disconnect circuit power and discharge all the high-voltage capacitors before testing diodes.

Use the diode test to check diodes, transistors, and other semiconductor devices. The diode test sends a current through the semiconductor junction, then measure the voltage drop across the junction. A good silicon junction drops between 0.5V and 0.8V

To test the diode out of a circuit, set up the Meter as Figure 3-5 and proceed as follows:

1. Insert the red test lead into the  $\Omega$  terminal and the black test lead into the **COM** terminal.
2. Set the rotary switch to  $\Omega$  ; and press **BLUE** button to select  measurement mode.

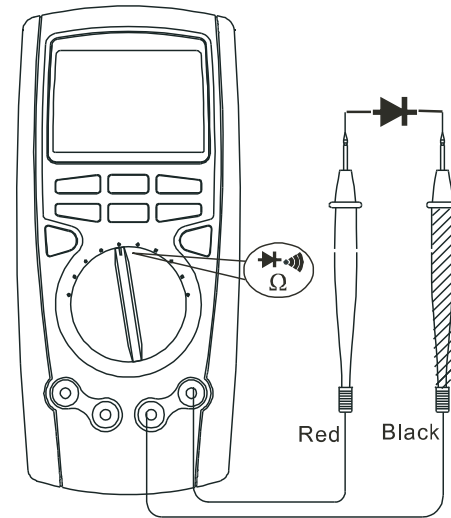


Figure 3-5. Diode Test



3. For forward voltage drop readings on any semiconductor component, place the red test lead on the component's anode and place the black test lead on the component's cathode. The red test lead polarity is "+" while the black test lead polarity is "-". The measured value shows on the display.

The **BLUE** button cycles among resistance, continuity, and diode.

### Note

- 1 In a circuit, a good diode should still produce a forward voltage drop reading of 0.5V to 0.8V; however, the reverse voltage drop reading can vary depending on the resistance of other pathways between the probe tips.
- 1 Connect the test leads to the proper terminals as said above to avoid error display.
- 1 The LCD will display **OL** indicating either open circuit or wrong polarity connection.
- 1 The unit of diode is volt (V), displaying the positive-connection voltage-drop value.
- 1 Open circuit voltage approximate 2.8V.

- 1 When diode testing has been completed, disconnect the connection between the testing leads and the circuit under test and remove the test leads away from the input terminals.

## F. Measuring Capacitance


### Warning

To ensure accuracy, the Meter inside is discharged against the tested capacitor. "DIS.C" will be shown on the display when it is under discharging, this process will be quite slow.

To avoid damage to the Meter or to the equipment under test, disconnect circuit power and discharge all high-voltage capacitors before measuring capacitance.

Use the DC Voltage function to confirm that the capacitor is discharged.

To measure capacitance, set up the Meter as shown in Figure 3-6 and proceed as follows:

1. Insert the red test lead into the  terminal and the black test lead into the **COM** terminal.

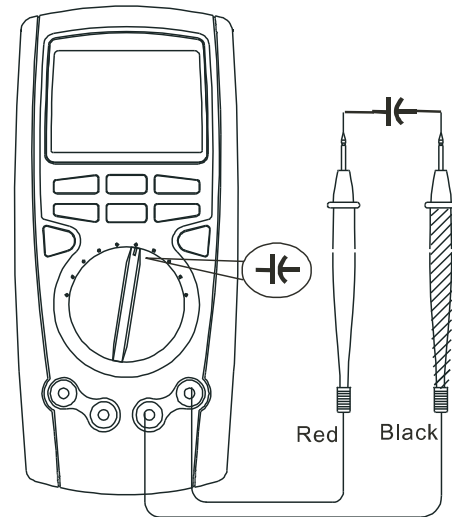




Figure 3-6. Capacitance Measurement

2. Set the rotary switch to  measurement mode, the Meter may display a fixed reading which is a internal distributed capacitor value. For testing less than 10nF capacitor, the tested value must subtract the internal distributed capacitor value to maintain the accuracy.

To improve the measurement accuracy of small value capacitors (less than 10nF), press **REL**  with the test leads open to subtract the residual capacitance of the Meter and leads.

3. It is recommended to use test clip to carry out measurement to reduce the effect of internal distributed capacitor.

### Note

- 1 The LCD displays **OL** indicating the tested capacitor is shorted or it exceeds the maximum range.
- 1 Capacitors larger than 400 $\mu$ F take longer time. The analogue bar graph shows the time left before finishing the measurement.

- 1 When capacitance measurement has been completed, disconnect the connection between the testing leads and the circuit under test and remove the test leads away from the input terminals of the Meter.

## G. Measuring Frequency / Duty Cycle

### Warning

To avoid harms to you, please do not attempt to input voltage higher than 30V rms.

To measure frequency and duty cycle, connect the Meter as Figure 3-7 and do the following:

1. Insert the red test lead into the Hz terminal and the black test lead into the COM terminal.
2. Set the rotary switch to Hz% (UT71A), Hz% $\overline{mV}$  (UT71B/C/D) or  $\frac{Hz}{\circ C}$  /  $\frac{\%}{\circ F}$  (UT71E) and press BLUE button to select the Hz measurement mode for frequency measurement or % for duty cycle measurement. The BLUE button cycles among mV $\overline{mV}$ , frequency and duty cycle for UT71C and UT71E.
3. Connect the test leads across with the object being measured.  
The measured value shows on the primary display.

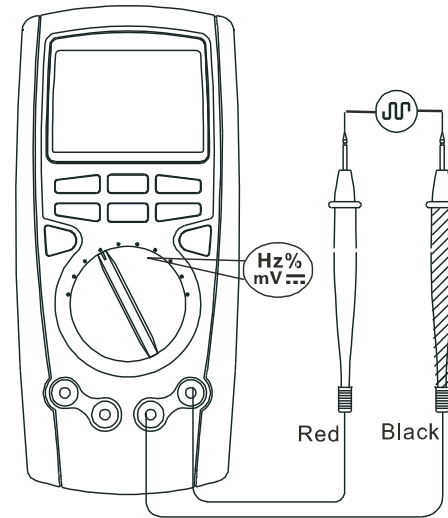


Figure 3-7. Frequency / Duty Cycle Measurement

## Note

- 1 The requirement of Input amplitude "a" is as follows:  
When 10Hz~40MHz:  $200 \text{ mV} \leq a \leq 30\text{Vrms}$ ;  
> 40MHz: Un-specified
- 1 When Hz measurement has been completed, disconnect the connection between the testing leads and the circuit under test and remove the test leads away from the input terminals.

## H. Measuring Temperature

### ⚠ Warning

To avoid harms to you, please do not attempt to input voltages higher than 60V DC or 30V rms AC.

To measure temperature, set up the Meter as shown in Figure 3-8 and proceed the following.

1. Set the rotary switch to °C °F, the display shows OL. Short circuit the test leads to show the room temperature. The Meter is default to Celsius °C degree unit, you can change units by press the BLUE button once you have selected the temperature function.
2. Insert the point contact temperature probe into the Meter as figure 10.
3. Place the temperature probe to the object being measured.  
The measured value shows on the display after several seconds.

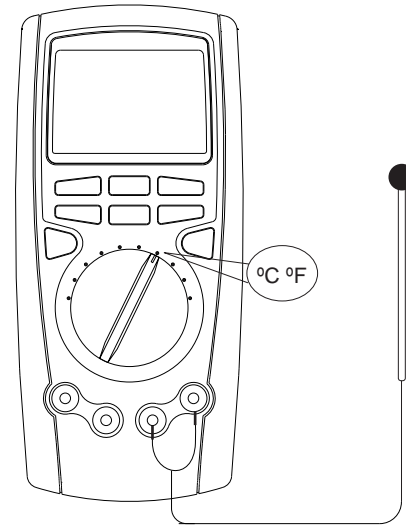


Figure 3-8. Temperature Measurement

## Note

- 1 Place the Meter in an environment of 18°C~23°C otherwise false reading may be obtained especially in testing low temperature.
- 1 The included point contact temperature probe can only be used with temperature 230°C below.
- 1 When temperature measurement has been completed, remove the temperature probe away from the multi-purpose socket, and remove the multi-purpose socket away from the Meter.

## I. 4~20 mA loop current as % readout(UT71B/C/D/E)

It shows the mA measured value or output level in %, in a 4-20mA scale

To use 4~20mA Loop feature, connect the Meter as follows:

1. Set the rotary switch to  $\overline{\sim}$   $\frac{4\sim 20\text{mA}}{\%}$ , and press BLUE button to select (4~20mA)% feature.

2. The rest procedure, please follow B. Measuring Current: DC current measurement (Figure 3-2).
3. When the readings obtained is:
  - 1 < 4mA, the primary display shows LO
  - 1 14mA, the primary display shows 0%. ....
  - 20mA, the primary display shows 100%
  - 1 > 20mA, the primary display shows HI

### J. Power Measurement (UT71E only)

#### Warning

To avoid damages to the Meter, please do not attempt to input higher than 250V from outlet altogether reading may be obtained.

Take extra care during measurement to avoid electric shock.

Switch off the power before the Meter and the object being measured connect to the circuit.

To measure power, proceed the following:

1. Set the rotary switch to **W**.
2. Insert the power adaptor to the corresponding input terminals, and plug the power adaptor to the outlet.
3. Insert the object to be measured into the outlet of the power adaptor.
4. The measured value shows on the display. The primary display shows the power value, the left secondary display show the power factor value and right secondary display shows the apparent power value.

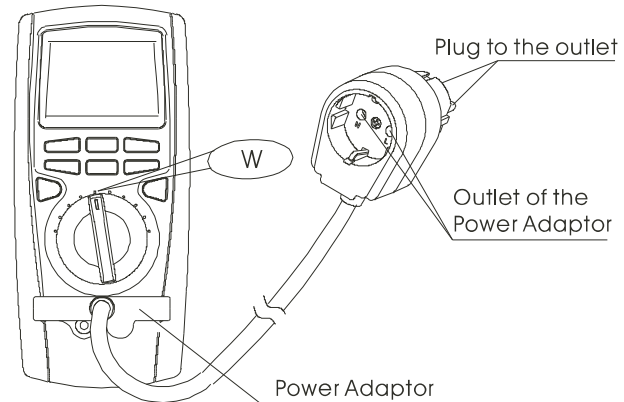


Figure 3-9. Power Measurement



## Note

- 1 The current of the object being measured must  $> 10A$ .  
 $\leq 5A$  continuous measurement is allowed.
- 1  $5A\sim 10A$ , only  $\leq 10$  seconds continuous measurement is allowed and the interval between each measurement must be greater than 15 minutes.  
When power measurement has been completed, first switch off the power, then disconnect the connection between the adaptor and the outlet.

## Chapter 4

### Using Store, Recall & Send Features

#### Introduction

Chapter 4 shows you how to use stores, recall and communication features available on the Meter

#### Storing and Clearing Readings

To store readings, proceed as follows:

- 1 Press **STORE** once, STO and "no.xxxx" appears to confirm the operation and the left secondary display shows the current measurement reading. Press ► to toggle between clearing the stored readings and start from the first readings or start from the last stored reading. Right secondary display shows the original number of records.
- 1 Press **STORE** the second time, STO appears. The left secondary display shows the storing time interval in second, it is preset to zero. To change the interval in second by pressing + or - button. The interval can

be as high as 255 seconds or as low as 0 second. Press and hold **STORE** to access the quick setting.

- 1 Press **STORE** the third time, STO and no appears. The left secondary display shows the index number increase one. The right secondary display shows the value of the corresponding index number, the primary display shows the current measurement reading.
- 1 If there is not set time to store the reading, each press of **STORE** to store one reading. An index number increase one.
- 1 The maximum number of stored reading is 100 (for UT71C and UT71E) and 9999 (for UT71D). When the stored readings memory is full, the Meter will stop storing data.
- 1 To exit, press **EXIT**. Automatic power off feature will be disabled after entering this mode.

### Recalling Stored Readings

Use the following procedure to recall the stored reading:

- 1 Press **RECALL** to recall the stored value and RCL appears to confirm the operation.
- 1 The left secondary display shows the index number "no.xxxx".
- 1 The primary display shows the corresponding recalled data.
- 1 The right secondary display shows the total number of the stored data.
- 1 Press ► button to enable the SEND feature to export the data to the computer via USB. The software shows the data storing time and also the data value. After the data transferring is completed, the SEND feature will be disabled automatically.
- 1 Press + or - button to view additional stored reading. Press and hold **RECALL** to access quick recalling.
- 1 Press **EXIT** to exit recalling.

### Using Send

When using a Send feature, please refer to the Installation Guide of the included CD-ROM.

## Chapter 5

### Changing the Default Setting

#### Introduction

The Meter allows you to change the default operating configuration of the Meter by changing setup options made at the factory.

These settings are stored and can be changed in the Setup mode using the procedure described in this chapter.

#### Selecting Setup Options

To enter the Setup mode, turn the Meter on and press and hold **SETUP** button for over 1 second. It is recommended to change the default setting only when the Meter is at DCV measurement mode.

In the Setup mode, each press of **SETUP** button steps to the next Selection. Each press of **-** or **+** button decrement or increment an Option.

Each Setup Selection and Option appears in the primary display in the sequence shown in Table 5-1.

**Table 5-1. Setup Selections**




Selection	Option	Factory Default	Description
<b>HIGH</b>	Max. 40000. Press ◀ to select OFF Press ▶ to select the digit you want to edit	OFF	Over the upper limits, beeps not continuously.
<b>LOW</b>	Max. 40000. Press ◀ to select OFF Press ▶ to select the digit you want to edit	OFF	Over the lower limits, beeps not continuously.
	10	10 mins	10 mins power off
	20		20 mins power off
	30		30 mins power off
	OFF		Power off feature is disabled
	1	1	Beeps continuously and icon lights on
	OFF		No beep, icon flashes
	10	10	Backlight turn off in 10 seconds
	20		Backlight turn off in 20 seconds
	30		Backlight turn off in 30 seconds
	OFF		Disable backlight feature.

Table 5-1. Setup Selections

Selection	Option	Factory Default	Description
Analogue Bar Graph	Zero is in the left hand side.	Zero is in the center	
	Zero is in the center		<p>It can only apply to DCV, DCI and °C/°F functions.</p>

## Saving Setup Options

At each setup Option, store your choice and exit setup by press EXIT, advance to the next Option by press +. To exit the Setup mode without saving the present Option, press Setup.

## Chapter 6 Maintenance

This chapter provides basic maintenance information including battery and fuse replacement instruction.



**Do not attempt to repair or service your Meter unless you are qualified to do so and have the relevant calibration, performance test, and service information.**

### A. General Service

- 1 Periodically wipe the case with a damp cloth and mild detergent. Do not use abrasives or solvents.
- 1 To clean the terminals with cotton bar with detergent, as dirt or moisture in the terminals can affect readings.
- 1 Turn the Meter to OFF when it is not in use.
- 1 Take out the battery when it is not using for a long time.
- 1 Do not use or store the Meter in a place of humidity, high temperature, explosive, inflammable and strong magnetic field.

## B. Replacing the Fuses

### Warning

To avoid electrical shock or arc blast, or personal injury or damage to the Meter, use specified fuses **ONLY** in accordance with the following procedure.

Follow Figure 6-1 and proceed as follows to replace the Meter's fuse:

- 1 Turn the rotary switch to OFF and remove all connections from the terminals.
- 1 Remove the 5 screws from the case bottom.
- 1 Remove the fuse by gently prying one end loose, then take out the fuse from its bracket.
- 1 Install **ONLY** replacement fuses with the identical type and specification as follows and make sure the fuse is fixed firmly in the bracket.
  - Fuse 1: 0.5A, 250V, fast type fuse,  $\phi$ 5x 20mm
  - Fuse 2: 10A, 250V, fast type fuse,  $\phi$ 5x 20mm
- 1 Rejoin the case bottom and case top, and install the 5 screws.

Replacement of the fuses is seldom required. Burning of a fuse always results from improper operation.

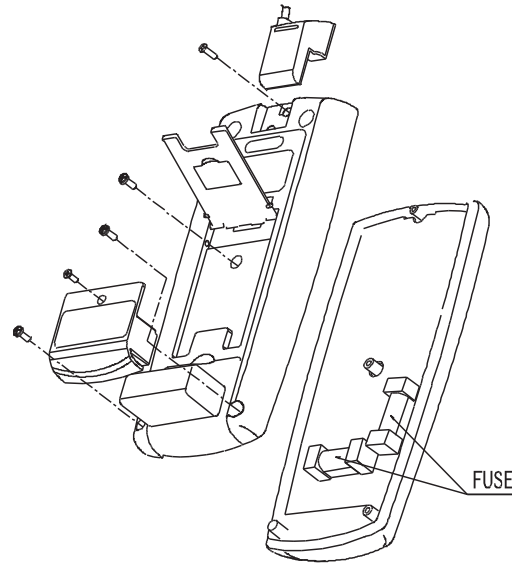



Figure 6-1. Fuse Replacement



### C. Replacing the Battery

#### Warning

To avoid false readings, which could lead to possible electric shock or personal injury, replace the battery as soon as the battery indicator "  " appears.

**Make sure the test leads are disconnected from the circuit being tested before opening the case bottom.**

Follow Figure 6-2 and proceed as follows to replace the battery:

- 1 Turn the rotary switch to OFF and remove all connections from the terminals.
- 1 Remove the screw from the battery compartment, and separate the battery compartment from the case bottom.
- 1 Replace with a new 6F22 9V battery.
- 1 Rejoin the case bottom and battery compartment, and reinstall the screw.

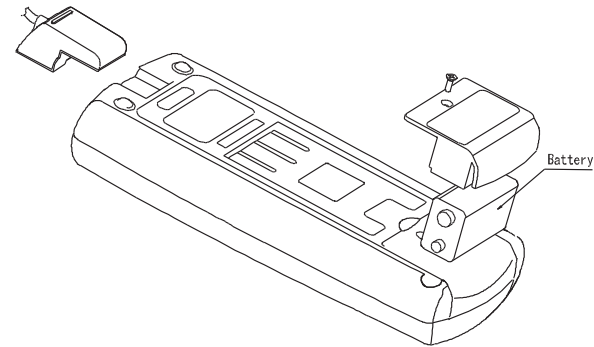




Figure 6-2. Battery Replacement

## Chapter 7 Specifications


### Safety and Compliances

Maximum Voltage between any Terminal and Grounding	Refer to different range input protection voltage
Certification	<b>CE</b>
Compliances	IEC 61010 CAT.III 1000V, CAT.IV 600V overvoltage and double insulation standard
 Fused Protection for <b>μAmA</b> input terminal:	0.5A, 250V, fast type fuse, φ 5x20mm
 Fused Protection for <b>A</b> input terminal:	10A , 250V,fast type fuse, φ 5x20mm

## Physical Specifications

Display (LCD)	Digital: 40000 counts on primary display; updates 2-3 times / second. 4000 counts on two secondary displays. Analog: 40 segments; updates 10 times / second.
Operating Temperature	0°C~40°C (32°F~104°F)
Storage Temperature	-10°C~50°C (14°F~122°F)
Relative Humidity	≤ 75% @ 0°C~30°Cæ below; ≤ 50% @ 30°C~40°C:
Battery Type	9V NEDA 1604 or 6F22 or 006P.
Electromagnetic Compatibility	l In a radio field of 1 V/m below: Overall Accuracy = Specified Accuracy + 5% of Range l In a radio field of 1 V/m above: No assigned accuracy is specified.
Dimensions (H x W x L)	177 x 85 x 40mm.
Weight	Approx.340g (including battery)

## General Specifications

Range	Auto
Polarity	Auto
Overloading	Display <b>OL</b> (except at 4~20mA Loop range which display <b>HI</b> or <b>LO</b> )
Battery Deficiency	Display 

### Feature Summary

Tri Digital Displays Analogue Bar Graph	Primary: 40,000 counts Left Secondary: 4000 counts Right Secondary: 4000 counts Bar Graph: 40 segments, updates 10 times / second
Backlight with 2 brightness levels	Bright backlight for clear readings in poorly lighted areas.
Autorange	The Meter automatically selects best range
AC+DC True RMS, AC RMS	Choices for AC only or AC+DC readings
Data Hold	Holds readings on display
Continuity	Beeper sounds for resistance readings below threshold.
Bar Graph	40 segments
Duty Cycle	Measure signal on or off time in %.
MAX MIN Mode	Record maximum and minimum
Battery Access Door	Battery replaceable.

## Basic Specifications

Function	Ranges / Description
DC Voltage	0 to 1000V
AC Voltage, True RMS	0 to 1000V, 100kHz bandwidth
Basic Accuracy	DC Voltage: 0.025% AC Voltage: 0.4%
DC Current	0 to 10A (5~10A for $\leq 10$ seconds, interval $\geq 15$ minutes)
AC Current, True RMS	0 to 10A (5~10A for $\leq 10$ seconds, interval $\geq 15$ minutes)
Resistance	0 to 40M $\Omega$ (UT71A/B is 0 to 20M $\Omega$ )
Capacitance	0 to 40mF(UT71A/B is 0 to 20mF)
Frequency	0~400MHz (UT71A/B is 0 to 200MHz)
Temperature	-40°C~1000°C (-40°F~1832°F)(UT71B/C)
STORE Readings	Up to 100 readings for UT71C and UT71E or 9999 readings for UT71D may be saved by the user in a memory. These readings may be viewed by using Recall feature.

## Detailed Accuracy Specifications

Accuracy:  $\pm$ ([% of reading] + [number of least significant digits]), guarantee for 1 year.

Operating temperature: 18°C~28°C

Relative humidity:  $\leq$  75%RH

### A. DC Voltage

Range		Resolution	Accuracy			Overload Protection	Input Impedance
UT71A/B	UT71C/D/E		UT71A	UT71B	UT71C/D/E		
200mV	400mV	0.01mV	$\pm(0.1\%+8)$	$\pm(0.05\%+5)$	$\pm(0.025\%+5)$	1000V	Around 2.5G $\Omega$
2V	4V	0.0001V		$\pm(0.08\%+5)$	$\pm(0.05\%+5)$		Around 10M $\Omega$
20V	40V	0.001V					
200V	400V	0.01V	$\pm(0.15\%+8)$	$\pm(0.1\%+8)$	$\pm(0.1\%+8)$		
1000V	1000V	0.1V					

**B. AC Voltage (AC+DC measurement is available)**

Range		Resolution	Bandwidth	Accuracy		
UT71A/B	UT71C/D/E			UT71A	UT71B	UT71C/D/E
2V	4V	0.0001V	45Hz~1kHz	$\pm(0.8\%+40)$	$\pm(0.6\%+40)$	$\pm(0.4\%+30)$
			1kHz~10kHz	$\pm(3\%+40)$	$\pm(3\%+40)$	$\pm(3\%+30)$
			10kHz~100kHz	$\pm(7\%+40)$	$\pm(7\%+40)$	$\pm(6\%+30)$
20V	40V	0.001V	45Hz~1kHz	$\pm(0.8\%+40)$	$\pm(0.6\%+40)$	$\pm(0.4\%+30)$
			1kHz~10kHz	$\pm(3\%+40)$	$\pm(3\%+40)$	$\pm(3\%+30)$
			10kHz~100kHz	$\pm(7\%+40)$	$\pm(7\%+40)$	$\pm(6\%+30)$
200V	400V	0.01V	45Hz~1kHz	$\pm(0.8\%+40)$	$\pm(0.6\%+40)$	$\pm(0.4\%+30)$
			1kHz~10kHz	$\pm(5\%+40)$	$\pm(5\%+40)$	$\pm(5\%+30)$
			10kHz~100kHz	Not Specified	Not Specified	Not Specified
1000V	1000V	0.1V	45Hz~1kHz	$\pm(1.5\%+40)$	$\pm(1.2\%+40)$	$\pm(1\%+30)$
			1kHz~5kHz	$\pm(6\%+40)$		$\pm(5\%+30)$
			5kHz~10kHz	$\pm(10\%+40)$		$\pm(10\%+30)$



**Remarks:**

1 Input Impedance: Approx 10MΩ.

1 Overload Protection: 1000V.

1 Display:

a) True rms are valid from 10% of range to 100% of range

b) AC crest factor can be up to 3.0 except 1000V where it is 1.5.

c) A residual reading of 80 digits with test leads shorted, will not affect stated accuracy.

d) When frequency is lower than 100kHz, the accuracy guarantee range 10%-100%.

e) When making AC+DC measurement, the accuracy need to add (1%+ 35 digits) of reading based on the above table.

## C. DC Current

Range		Resolution	Accuracy			Overload Protection
UT71A/B	UT71C/D/E		UT71A	UT71B	UT71C/D/E	
200μA	400μA	0.01μA	±(0.2%+20)	±(0.15%+20)	±(0.1%+15)	0.5A, 250V, fast type fuse, φ5x20mm
2000μA	4000μA	0.1μA			±(0.15%+15)	
20mA	40mA	0.001mA				
200mA	400mA	0.01mA				
10A	10A	0.001A	±(0.8%+30)	±(0.7%+30)	±(0.5%+30)	10A, 250V, fast type fuse, φ5x20mm

### Remarks:

#### At 10A range:

- 1 When the measured current is  $\leq 5A$ , continuous measurement is allowed.
- 1 When the measured current is between 5A-10A, continuous measurement  $\leq 10$  seconds and interval more than 15 minutes.

### D. AC Current (AC+DC measurement is available)

Range		Resolution	Bandwidth	Accuracy			Overload Protection
UT71A/B	UT71C/D/E			UT71A	UT71B	UT71C/D/E	
200μA	400μA	0.01μA	45Hz~1kHz 1kHz~10kHz	±(1%+15)	±(0.8%+15)	±(0.7%+15) ±(1%+40)	0.5A, 250V, fast type fuse, φ5x20mm
2000μA	4000μA	0.1μA		±(2%+40)	±(1.5%+40)		
20mA	40mA	0.001mA					
200mA	400mA	0.01mA					
10A	10A	0.001A	45Hz~1kHz	±(2%+20)	±(2%+20)	±(1.5%+20)	10A, 250V, fast type fuse, φ5x20mm
			1kHz~10kHz	±(6%+40)	±(6%+40)	±(5%+40)	

#### Remarks:

##### 1 Display:

- a) True rms are valid from 10% of range to 100% of range
- b) AC crest factor can be up to 3.0.
- c) A residual reading of 80 digits with test leads shorted, will not affect stated accuracy.
- d) When frequency is lower than 100kHz, the accuracy guarantee range 10%-100%.
- e) When making AC+DC measurement, the accuracy need to add (1%+ 35 digits) of reading based on the above table.

##### 1 At 10A range:

- a) When the measured current is ≤ 5A, continuous measurement is allowed.
- b) When the measured current is between 5A-10A, continuous measurement ≤ 10 seconds and interval more than 15 minutes.

short circuit value

## E. Resistance

Range		Resolution	Accuracy			Overload Protection
UT71A/B	UT71C/D/E		UT71A	UT71B	UT71C/D/E	
200Ω	400Ω	0.01Ω	±(0.5%+20)+test leads short circuit value	±(0.4%+20)+test leads short circuit value	±(0.3%+8)+test leads short circuit value	1000V
2kΩ	4kΩ	0.0001kΩ	±(0.5%+20)	±(0.4%+20)	±(0.3%+8)	
20kΩ	40kΩ	0.001kΩ				
200kΩ	400kΩ	0.01kΩ	±(1%+20)	±(0.8%+20)	±(0.5%+20)	
2MΩ	4MΩ	0.0001MΩ	±(1%+40)	±(1%+40)	±(1%+40)	
20MΩ	40MΩ	0.001MΩ	±(1.5%+40)	±(1.5%+40)	±(1.5%+40)	

## F. Continuity Test

Range	Resolution	Overload Protection
•••)	0.01Ω	1000V

### Remarks:

- 1 Open circuit voltage approximate -1.2V.
- 1 The buzzer does not sound when the test resistance is > 60Ω.
- 1 The beeper comes on continuously for open conditions, that is test resistance is ≤ 40Ω.

### G. Diode Test

Range	Resolution	Overload Protection
↔	0.0001V	1000V

#### Remarks:

- 1 Open circuit voltage approximate 2.8V.
- 1 A good silicon junction drops between 0.5V and 0.8V.

### H. Capacitance

Range		Resolution	Accuracy			Overload Protection
UT71A/B	UT71C/D/E		UT71A	UT71B	UT71C/D/E	
20nF	40nF	0.001nF	$\pm(1.5\%+20)+$ capacitance value of open circuit test leads	$\pm(1.2\%+20)+$ capacitance value of open circuit test leads	$\pm(1\%+20)+$ capacitance value of open circuit test leads	1000V
200nF	400nF	0.01nF	$\pm(1.5\%+20)$	$\pm(1.2\%+20)$	$\pm(1\%+20)$	
2 $\mu$ F	4 $\mu$ F	0.0001 $\mu$ F				
20 $\mu$ F	40 $\mu$ F	0.001 $\mu$ F	$\pm(1.5\%+40)$	$\pm(1.2\%+40)$	$\pm(1.2\%+20)$	
200 $\mu$ F	400 $\mu$ F	0.01 $\mu$ F		$\pm(1.5\%+40)$		
2mF	4mF	0.0001mF	$\pm(5\%+40)$	$\pm(5\%+40)$	$\pm(5\%+20)$	
20mF	40mF	0.001 mF	Not specified	Not specified	Not specified	

## I. Frequency

Range		Resolution	Accuracy		Overload Protection
UT71A/B	UT71C/D/E		UT71A/B	UT71C/D/E	
20Hz	40Hz	0.001Hz	±(0.1%+15)	±(0.01%+8)	1000V
200Hz	400Hz	0.01Hz			
2kHz	4kHz	0.0001kHz			
20kHz	40kHz	0.001kHz			
200kHz	400kHz	0.01kHz			
2MHz	4MHz	0.0001MHz			
20MHz	40MHz	0.001MHz			
200MHz	400MHz	0.01MHz	Not Specified	Not Specified	

### Remarks:

- Input amplitude "a" as follows; (DC electric level is zero)  
 When 10Hz~40MHz :  $200\text{mV} \leq a \leq 30\text{Vrms}$ ;  
 When > 40MHz : Not specified

## J. Temperature (UT71B/C/D/E)

### Degrees Celsius

Range	Resolution	Accuracy	Overload Protection
-40°C~40°C	0.1°C	$\pm(3\%+30)$	1000V
40°C~400°C		$\pm(1\%+30)$	
400°C~1000°C		$\pm 2.5\%$	

### Fahrenheit

Range	Resolution	Accuracy	Overload Protection
-40°F~32°F	0.1°F	$\pm(4\%+50)$	1000V
32°F~752°F		$\pm(1.5\%+50)$	
752°F~1832°F		$\pm 3\%$	

### Remarks:

- Included is a K-Type (nickel chromium ~ nickel silicon) point contact temperature probe which could only measure temperature below 230°C. If you want to measure temperature higher than 230°C, you must use the rod contact temperature probe.

### K. 4~20 mA loop current (UT71B/C/D/E)

Range	Resolution	Accuracy	Overload Protection
(4~20mA)%	0.01%	$\pm(1\%+50)$	0.5A, 250V, fast type fuse, $\phi 5 \times 20 \text{mm}$

**Remarks:**

When the readings obtained is:

l < 4mA, the primary display shows LO

l 4mA, the primary display shows 0% .... ; 20mA, the primary display shows 100%

l > 20mA, the primary display shows HI

### L. Power Measurement (UT71E only)

Range		Resolution	Accuracy	Current Overload Protection	Voltage Overload Protection
POWER	2500W	0.1 W	$\pm(2\%+10)$	10A, 250V, fast type fuse, $\phi 5 \times 20 \text{mm}$	1000V
VA POWER	2500W	1W	$\pm(2\%+10)$		
Cos $\phi$ POWER	0 ~ 1	0.001W	$\pm(1\%+10)$		

**Remarks:**

l Power factor input range: 0.000~1.000

l Voltage input impedance: around 10M $\Omega$ .

l Voltage input range: AC50~250V

\*\* END \*\*



This operating manual is subject to change without notice.  
©Copyright 2005 Uni-Trend Group Limited.  
All rights reserved.

Manufacturer:  
Uni-Trend Technology (China) Limited  
No 6, Gong Ye Bei 1st Road  
Songshan Lake National High-Tech Industrial  
Development Zone, Dongguan City  
Guangdong Province  
China  
Postal Code:523 808

Headquarters:  
Uni-Trend Group Limited  
Rm901, 9/F, Nanyang Plaza  
57 Hung To Road  
Kwun Tong  
Kowloon, Hong Kong  
Tel: (852) 2950 9168  
Fax: (852) 2950 9303  
Email: [info@uni-trend.com](mailto:info@uni-trend.com)  
<http://www.uni-trend.com>