



Features

- Three-Phase 340 ~ 550VAC wide range input (Dual phase operation possible)
- 63mm slim width
- Built-in passive PFC function compliance to EN61000-3-2
- High efficiency 92% and low power dissipation
- Protections: Short circuit / Overload / Over voltage / Over temperature
- Cooling by free air convection
- Full power between -30~+60°C
- Built-in constant current limiting circuit
- Can be installed on DIN rail TS-35/7.5 or 15
- UL61010(industrial control equipment)approved
- EN61000-6-2(EN50082-2) industrial immunity level
- DC OK relay contact
- 3 years warranty

Applications

- Industrial control system
- Semiconductor fabrication equipment
- Factory automation
- Electro-mechanical apparatus

Description

TDR-240 is one economical slim 240W Din rail power supply series, adapt to be installed on TS-35/7.5 or TS-35/15 mounting rails. The body is designed 63mm in width, which allows space saving inside the cabinets. The entire series adopts the full range AC input from 3 ϕ 340VAC to 550VAC (Dual Phase operation possible) and conforms to EN61000-3-2, the norm the European Union regulates for harmonic current. TDR-240 is designed with metal housing that enhances the unit's power dissipation. With working efficiency up to 92 %, the entire series can operate at the ambient temperature between -30°C and 70°C under air convection. It is equipped with constant current mode for over-load protection, fitting various inductive or capacitive applications. The complete protection functions and relevant certificates for industrial control apparatus (UL61010, EN61558-2-16 approved, and etc.) make TDR-240 a very competitive power supply solution for industrial applications.

Model Encoding

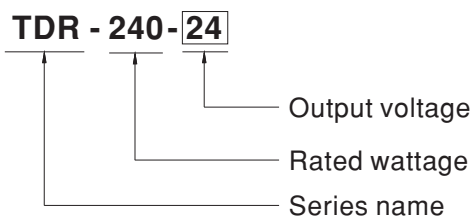



SPECIFICATION

MODEL		TDR-240-24	TDR-240-48	
OUTPUT	DC VOLTAGE	24V	48V	
	RATED CURRENT	10A	5A	
	CURRENT RANGE	0 ~ 10A	0 ~ 5A	
	RATED POWER	240W	240W	
	RIPPLE & NOISE (max.) <small>Note.2</small>	100mVp-p	120mVp-p	
	VOLTAGE ADJ. RANGE	24 ~ 28V	48 ~ 55V	
	VOLTAGE TOLERANCE <small>Note.3</small>	± 1.0%	± 1.0%	
	LINE REGULATION	± 0.5%	± 0.5%	
	LOAD REGULATION	± 1.0%	± 1.0%	
	SETUP, RISE TIME	2000ms, 60ms/400VAC 1500ms, 60ms/500VAC at full load		
HOLD UP TIME (Typ.)	20ms / 400VAC 40ms / 500VAC at full load			
INPUT	VOLTAGE RANGE <small>Note.4</small>	Three-Phase 340 ~ 550VAC (Dual phase operation possible in connecting L1,L3,FG or L2,L3,FG) or 480 ~ 780VDC		
	FREQUENCY RANGE	47 ~ 63Hz		
	POWER FACTOR (Typ.)	PF ≥ 0.53/400VAC PF ≥ 0.52/500VAC at full load		
	EFFICIENCY (Typ.)	92%	92%	
	AC CURRENT (Typ.)	0.69A/400VAC 0.6A/500VAC		
	INRUSH CURRENT (Typ.)	COLD START 50A		
	LEAKAGE CURRENT	<2mA / 530VAC		
PROTECTION	OVERLOAD	105 ~ 130% rated output power Protection type : Constant current limiting, unit will hiccup after 3 sec.		
	OVER VOLTAGE	30 ~ 36V	56 ~ 65V	
	OVER TEMPERATURE	Shut down o/p voltage, recovers automatically after temperature goes down		
FUNCTION	DC OK REALY CONTACT RATINGS (max.)	60VDC/0.3A, 30VDC/1A, 30VAC/0.5A resistive load		
ENVIRONMENT	WORKING TEMP. <small>Note.5</small>	-30 ~ +70°C (Refer to "Derating Curve")		
	WORKING HUMIDITY	20 ~ 95% RH non-condensing		
	STORAGE TEMP., HUMIDITY	-40 ~ +85°C, 10 ~ 95% RH non-condensing		
	TEMP. COEFFICIENT	± 0.05%/°C (0 ~ 60°C)		
	VIBRATION	Component:10 ~ 500Hz, 2G 10min./1cycle, 60min. each along X, Y, Z axes; Mounting: Compliance to IEC60068-2-6		
	OPERATING ALTITUDE <small>Note.6</small>	5000 meters		
SAFETY & EMC (Note 7)	OVER VOLTAGE CATEGORY	III ; According to EN61558, EN50178, EN60664-1, EN62477-1, EN60204-1; altitude up to 2000 meters		
	SAFETY STANDARDS	UL61010, EN61558-2-16, EAC TP TC 004 approved		
	WITHSTAND VOLTAGE	I/P-O/P:4.87KVAC I/P-FG:2.4KVAC O/P-FG:0.5KVAC O/P-DC OK:0.5KVAC		
	ISOLATION RESISTANCE	I/P-O/P, I/P-FG, O/P-FG:>100M Ohms / 500VDC / 25°C / 70% RH		
	EMC EMISSION	Parameter	Standard	Test Level / Note
		Conducted	EN61204-3	Class B
		Radiated	EN61204-3	Class B
		Harmonic Current	EN61000-3-2	Class A
		Voltage Flicker	EN61000-3-3	-----
	EMC IMMUNITY	EN55024 , EN61204-3		
		Parameter	Standard	Test Level / Note
		ESD	EN61000-4-2	Level 4, 15KV air ; Level 4, 8KV contact
		Radiated Field	EN61000-4-3	Level 3
EFT / Burst		EN61000-4-4	Level 3	
Surge		EN61000-4-5	Level 4, 2KV / Line-Line, Level 4, 4KV/ Line-Earth	
Conducted		EN61000-4-6	Level 3	
Magnetic Field		EN61000-4-8	Level 4	
Voltage Dips and Interruptions	EN61000-4-11	> 95% dip 0.5 periods, 30% dip 25 periods > 95% interruptions 250 periods		
OTHERS	MTBF	515.4K hrs min. Telcordia SR-332(Bellcore); 215.6K hrs min. MIL-HDBK-217F (25°C)		
	DIMENSION	63*125.2*113.5mm (W*H*D)		
	PACKING	1Kg ; 12pcs/13Kg/1.06CUFT		
NOTE	<ol style="list-style-type: none"> All parameters NOT specially mentioned are measured at 400VAC input, rated load and 25°C of ambient temperature. Ripple & noise are measured at 20MHz of bandwidth by using a 12" twisted pair-wire terminated with a 0.1uf & 47uf parallel capacitor. Tolerance : includes set up tolerance, line regulation and load regulation. Dual phase operation is allowed under certain derating to output load. Please refer to derating curves for details. Installation clearances : 40mm on top, 20mm on the bottom, 5mm on the left and right side are recommended when loaded permanently with full power. In case the adjacent device is a heat source, 15mm clearance is recommended. The ambient temperature derating of 3.5°C/1000m is needed for operating altitude higher than 2000m(6500ft). The power supply is considered a component which will be installed into a final equipment. The final equipment must be re-confirmed that it still meets EMC directives. For guidance on how to perform these EMC tests, please refer to "EMI testing of component power supplies." (as available on http://www.meanwell.com) 			

■ BLOCK DIAGRAM

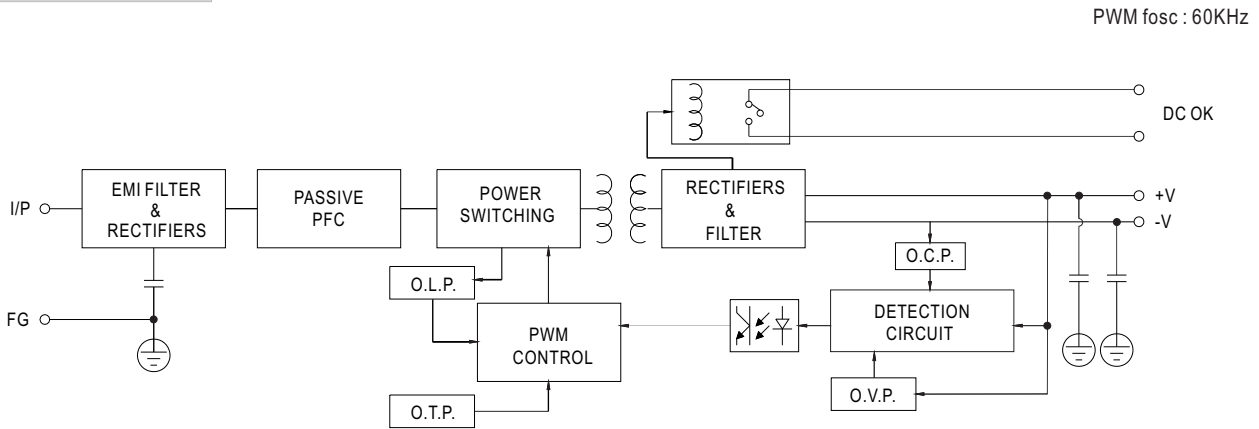

■ DERATING CURVE

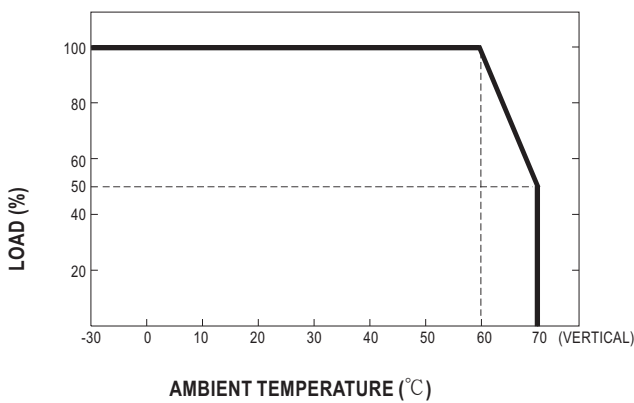

■ OUTPUT DERATING VS INPUT VOLTAGE

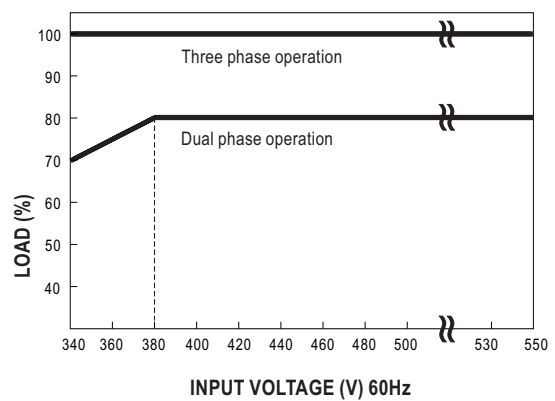

Note : When the dual phase input voltage is between 340~380Vac and ambient temperature is between -10°C~-30°C, the power supply may experience hiccup at cold start. The power supply will start up normally after 5~10 seconds.

■ DC OK RELAY CONTACT

Contact Close	PSU turns on / DC OK.
Contact Open	PSU turns off / DC Fail.
Contact Ratings (max.)	30VDC/1A, 30VAC/0.5A resistive load.

Terminal Pin No. Assignment (TB2)

Pin No.	Assignment
5,6	DC OK Relay Contact

※ Please contact MEAN WELL for more details.

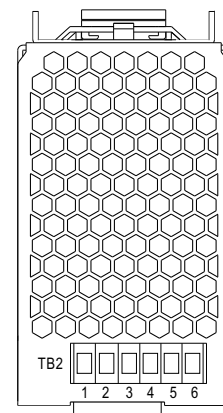

MECHANICAL SPECIFICATION

Case No. 979D Unit:mm

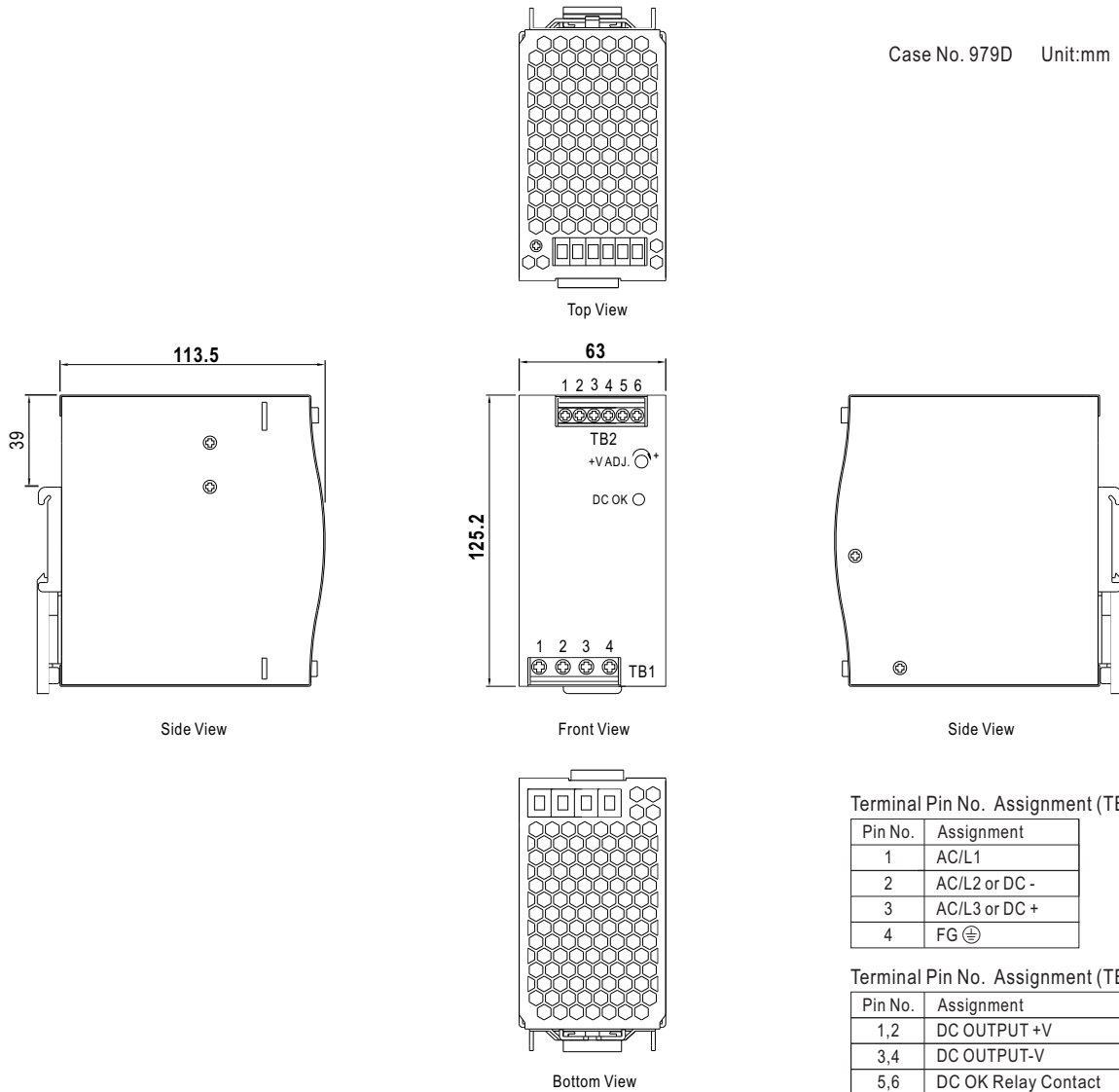

Installation Instruction

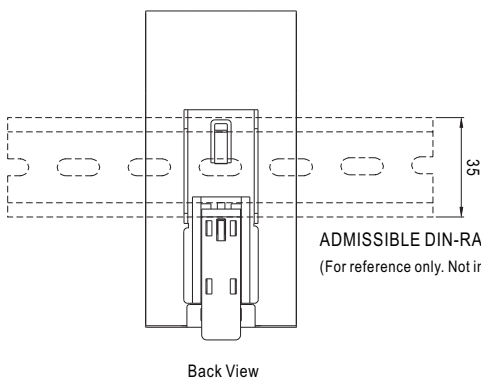

This series fits DIN-RAIL TS35/7.5 or TS35/15.
For installation details, please refer to the Instruction manual.

Installation Manual

Please refer to : <http://www.meanwell.com/manual.html>